

PROJECT: _____	UNIT TAG: _____	QUANTITY: _____
REPRESENTATIVE: _____	TYPE OF SERVICE: _____	DATE: _____
ENGINEER: _____	SUBMITTED BY: _____	DATE: _____
CONTRACTOR: _____	APPROVED BY: _____	DATE: _____
	ORDER NO.: _____	DATE: _____



UP 15-18 B5

Circulator pumps

Product photo could vary from the actual product

Conditions of Service	Pump Data	Motor Data
Flow: _____	Maximum operating pressure: 145 psi	Max. power input: 85 W
Head: _____	Liquid temperature range: 35.6 .. 230 °F	Rated power - P2: 0.04 HP
Efficiency: _____	Maximum ambient temperature: 104 °F	Rated voltage: 115 V
Liquid: _____	Approvals: UL, CSA	Main frequency: 60 Hz
Temperature: _____	Type of connection: Bronze Sweat	Insulation class: F
NPSH required: _____	Flange standard: USA Sweat	Motor protection: Contact
Viscosity: _____	Pipe connection: 1/2" Sweat	Thermal protection: internal
Specific Gravity: _____	Product number: 59896114	

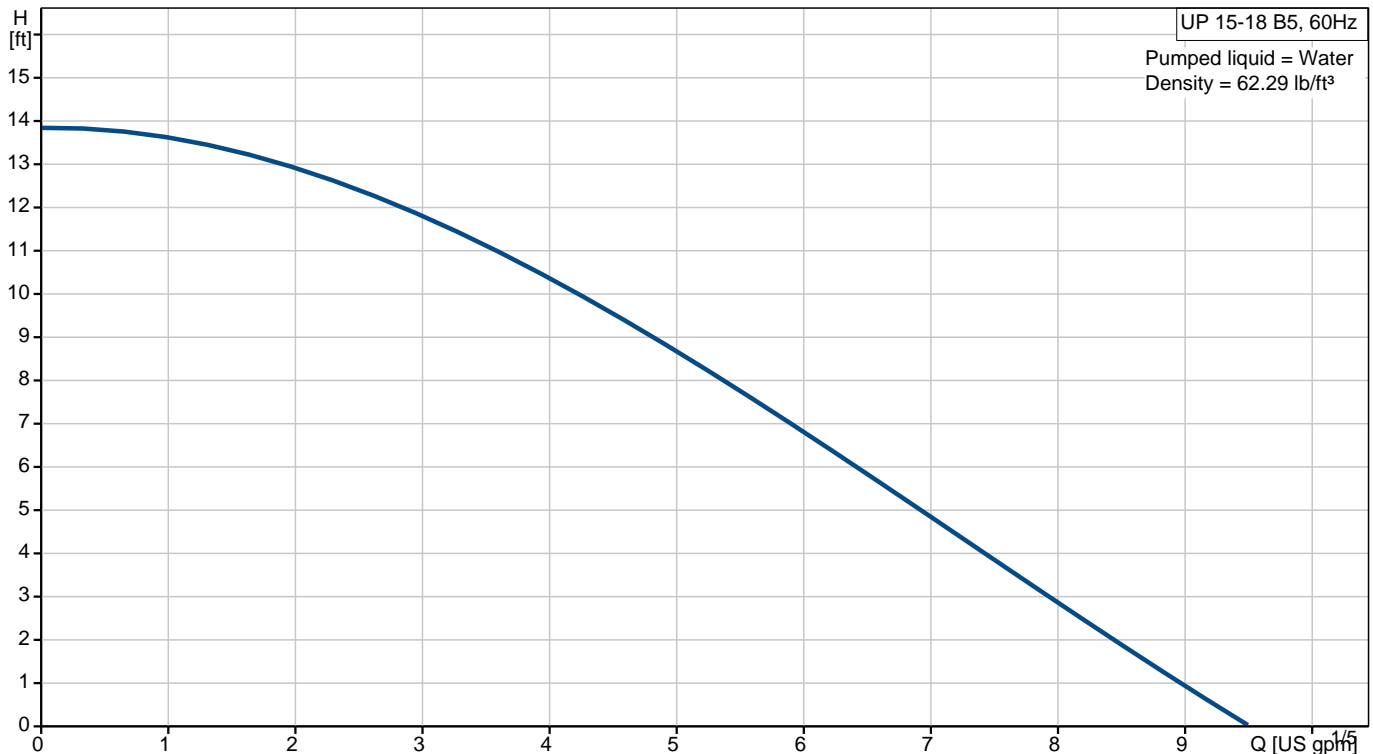

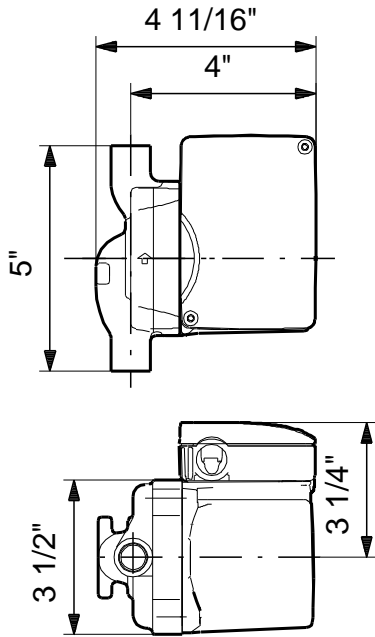

Materials:

Pump housing: Bronze
DIN W.-Nr. 2.1176.01

Impeller: Composite, PES



Position	Count	Description
	1	<p>UP 15-18 B5</p>  <p style="text-align: center;">Product photo could vary from the actual product</p> <p>Product No.: 59896114</p> <p>The pump is of the canned rotor type, i.e. pump and motor form an integral unit without shaft seal and with only two gaskets for sealing. The bearings are lubricated by the pumped liquid. The pump is characterized by:</p> <ul style="list-style-type: none"> * Ceramic shaft and radial bearings. * Carbon axial bearing. * Stainless steel rotor can and bearing plate. * Corrosion-resistant impeller, Composite, PES. * Bronze pump housing. <p>The motor is a 1-phase motor. No additional motor protection is required.</p> <p>Liquid: Liquid temperature range: 35.6 .. 230 °F</p> <p>Technical: Approvals on nameplate: UL, CSA</p> <p>Materials: Pump housing: Bronze DIN W.-Nr. 2.1176.01 Impeller: Composite, PES</p> <p>Installation: Maximum ambient temperature: 104 °F Ambient max at 176°F liquid: 176 °F Maximum operating pressure: 145 psi Flange standard: USA Sweat Type of connection: Bronze Sweat Pipe connection: 1/2" Sweat Pressure stage: 10 Port-to-port length: 5 in</p> <p>Electrical data: Number of poles: 2 Max. power input: 85 W Rated power - P2: 0.04 HP</p>



Company name: PexUniverse.com
Created by: Tech Support
Phone: 800-818-3201
Fax: 800-818-3211
Date: 03/27/2014

Position	Count	Description
		Main frequency: 60 Hz Rated voltage: 1 x 115 V Current in speed 3: 0.74 A Capacitor size - run: 10 μ F/180 V Insulation class (IEC 85): F Others: Gross weight: 6 lb

Description	Value
Product name:	UP 15-18 B5
Product No.:	59896114
EAN:	5700391411250
Price:	On request
Technical:	
Speed Number:	1
Max flow:	14.5 US gpm
Head max:	13.8 ft
Approvals on nameplate:	UL, CSA
Materials:	
Pump housing:	Bronze
	DIN W.-Nr. 2.1176.01
Impeller:	Composite, PES
Installation:	
Maximum ambient temperature:	104 °F
Ambient max at 176°F liquid:	176 °F
Maximum operating pressure:	145 psi
Flange standard:	USA Sweat
Type of connection:	Bronze Sweat
Pipe connection:	1/2" Sweat
Pressure stage:	10
Port-to-port length:	5 in
Liquid:	
Liquid temperature range:	35.6 .. 230 °F
Electrical data:	
Number of poles:	2
Max. power input:	85 W
Rated power - P2:	0.04 HP
Main frequency:	60 Hz
Rated voltage:	1 x 115 V
Current in speed 3:	0.74 A
Capacitor size - run:	10 µF/180 V
Insulation class (IEC 85):	F
Motor protection:	Contact
Thermal protec:	internal
Controls:	
Pos term box:	9H
Others:	
Gross weight:	6 lb

