

PROJECT: _____	UNIT TAG: _____	QUANTITY: _____
REPRESENTATIVE: _____	TYPE OF SERVICE: _____	DATE: _____
ENGINEER: _____	SUBMITTED BY: _____	DATE: _____
CONTRACTOR: _____	APPROVED BY: _____	DATE: _____
	ORDER NO.: _____	DATE: _____

MQ3-35

Self-priming multistage centrifugal pumps



Product photo could vary from the actual product

Conditions of Service	Pump Data	Motor Data
Flow: _____	Maximum operating pressure: 109 psi	Rated voltage: 110-120 V
Head: _____	Liquid temperature range: 32 .. 95 °F	Main frequency: 60 Hz
Efficiency: _____	Maximum ambient temperature: 113 °F	Enclosure class: IP54
Liquid: _____	Approvals: CSACUS	Insulation class: B
Temperature: _____	Shaft seal: BVBP	
NPSH required: _____	Pipe connection: NPT 1	
Viscosity: _____	Product number: 96860172	
Specific Gravity: _____		

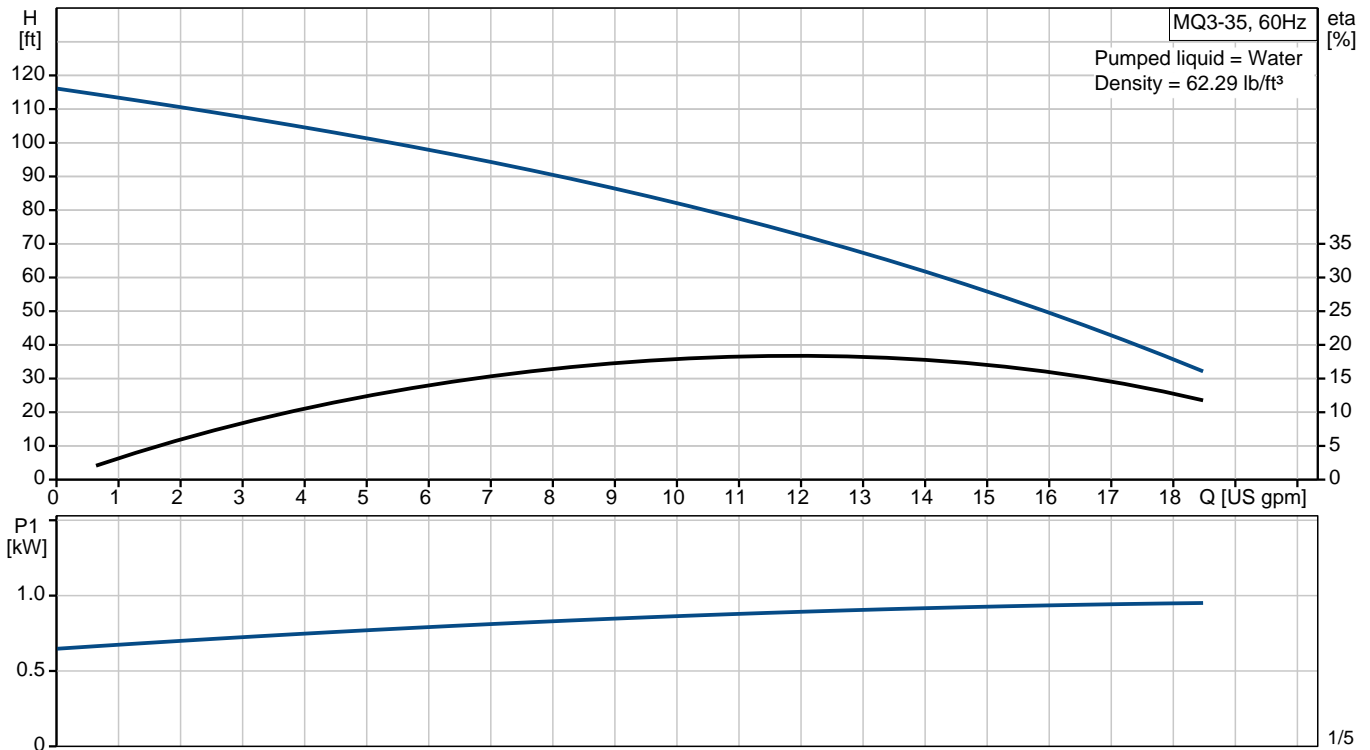

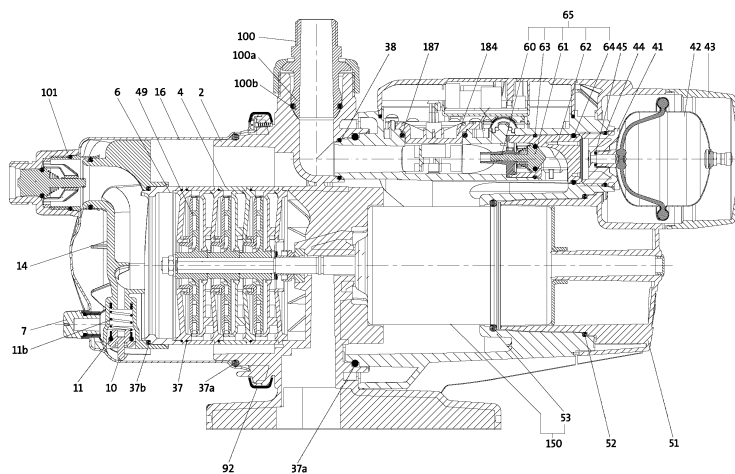
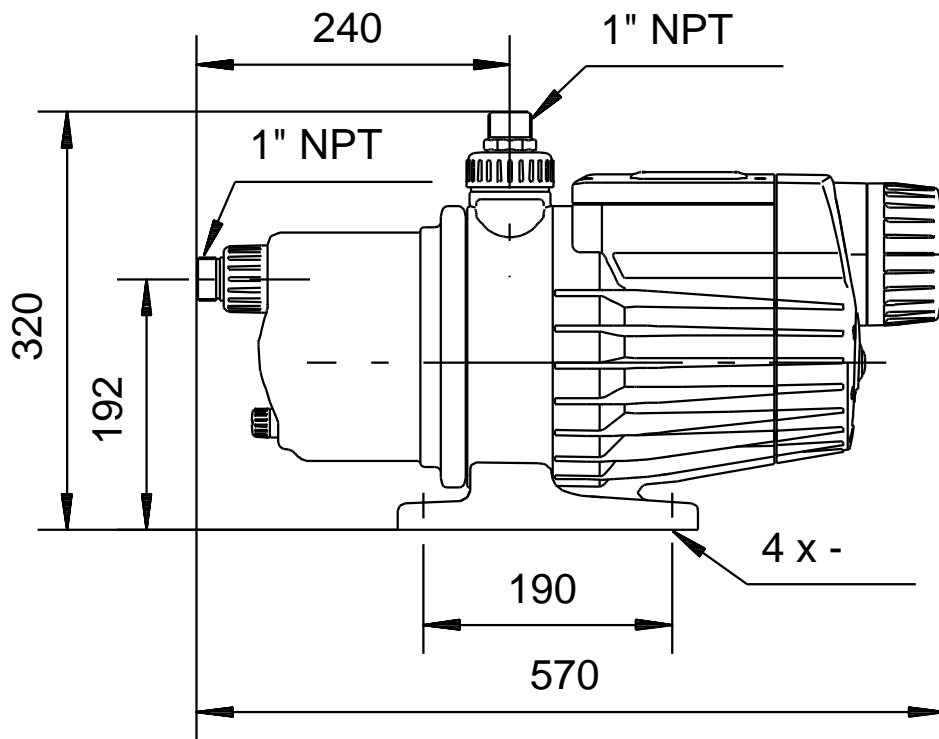

Materials:

Pump housing: POM + 25% glass fiber
 Impeller: PPO + 20% glass fiber-PTFE
 Material code: A



Position	Count	Description
	1	<p>MQ3-35 A-B-A-BVBP</p>  <p style="text-align: center;">Product photo could vary from the actual product</p> <p>Product No.: 96860172</p> <p>Complete system The MQ is a complete, all-in-one unit, incorporating pump, motor, diaphragm tank, pressure and flow sensor, controller and non-return valve. The controller ensures that the pump starts automatically when water is consumed and stops automatically when consumption ceases. In addition, the controller protects the pump in case of faults.</p> <p>Installation Due to its compact design, the pump does not take up much space and is easy to install. No space around the pump is required.</p> <p>Simple operation The pump features a user-friendly control panel with ON/OFF button and indicator lights to show the operational state of the pump.</p> <p>Self-priming pump As it is self-priming, the MQ is able to pump water from a level below the pump. Provided it is filled with water, the pump is able to lift water from a depth of 26 ft in less than 5 minutes. This facilitates installation and start-up of the pump and provides more reliable water supply in installations where there is a risk of dry running or leakages in suction hose or pipes.</p> <p>Built-in protective functions If exposed to dry running or excessive temperature, for example in case of seizure or overload, the pump will stop automatically, thus preventing a motor burnout.</p> <p>Automatic reset The pump features an automatic reset function. In case of dry running or similar alarm, the pump will stop. Restarting will be attempted every 30 minutes for a period of 24 hours. The reset function can be deactivated.</p> <p>Low noise level Thanks to its hydraulic design and internal cooling, the pump is extremely low-noise, which makes it suitable for indoor and outdoor use.</p> <p>Pressure tank The built-in pressure tank reduces the number of starts and stops in case of leakages in the pipe system, causing less wear on the pump.</p> <p>Maintenance No maintenance of the pump is required.</p>



Company name: PexUniverse.com
Created by: Tech Support
Phone: 800-818-3201
Fax: 800-818-3211
Date: 03/27/2014

Position	Count	Description
		<p>Liquid: Liquid temperature range: 32 .. 95 °F</p> <p>Technical: Rated flow: 13.2 US gpm Rated head: 72.2 ft Shaft seal: BVBP Approvals on nameplate: CSACUS Curve tolerance: ISO 9906:1999 Annex A</p> <p>Materials: Pump housing: POM + 25% glass fiber Impeller: PPO + 20% glass fiber-PTFE</p> <p>Installation: Range of ambient temperature: 32 .. 113 °F Maximum operating pressure: 109 psi Pipe connection: NPT 1</p> <p>Electrical data: Power input - P1: 900 W Main frequency: 60 Hz Rated voltage: 1 x 110-120 V Rated current: 8 A Enclosure class (IEC 34-5): IP54 Insulation class (IEC 85): B Length of cable: 6.56 ft Type of cable plug: NEMA</p> <p>Others: Net weight: 28.7 lb Gross weight: 34.2 lb Shipping volume: 1.94 ft³</p>

Description	Value
Product name:	MQ3-35 A-B-A-BVBP
Product No.:	96860172
EAN:	5700312084198
Price:	On request

Technical:	
Rated flow:	13.2 US gpm
Rated head:	72.2 ft
Head max:	115 ft
Shaft seal:	BVBP
Approvals on nameplate:	CSACUS
Curve tolerance:	ISO 9906:1999 Annex A
Pump version:	A
Model:	B

Materials:	
Pump housing:	POM + 25% glass fiber
Impeller:	PPO + 20% glass fiber-PTFE
Material code:	A

Installation:	
Range of ambient temperature:	32 .. 113 °F
Maximum operating pressure:	109 psi
Connect code:	B
Pipe connection:	NPT 1

Liquid:	
Liquid temperature range:	32 .. 95 °F

Electrical data:	
Power input - P1:	900 W
Main frequency:	60 Hz
Rated voltage:	1 x 110-120 V
Rated current:	8 A
Enclosure class (IEC 34-5):	IP54
Insulation class (IEC 85):	B
Length of cable:	6.56 ft
Type of cable plug:	NEMA

Controls:	
Switch:	on/off switch included

Others:	
Net weight:	28.7 lb
Gross weight:	34.2 lb
Shipping volume:	1.94 ft³
Sales region:	Namreg

