



Valves

 **MATCO-NORCA**
Global sourcing. National compliance. Local service.

C A L I F O R N I A • T E X A S • N E W Y O R K

Table of Contents

ITEM NAME PAGE NUMBER

A
 Angle Control Valve15
 Angle Valve20, 29, 33
 Aztec Boiler Drain22
 Aztec Garden Valve22
 Aztec Hose Bibb22, 24
 Aztec Low Pressure Valves22-24
 Aztec Sillcocks23

B
 Back Flow Preventers22
 Balancing Valves34
Ball Valves

Carbon Steel39, 40, 42
 Compression Ends7
 CPVC11
 CSA4-5
 Drop Ear7
 Full Port4-7
 Gas8
 Heavy Duty5
 Hose Bibb25
 Locking Handles4
 Long Bonnet6
 Male X Female4, 7
 Nickel Plated5-6
 One Piece5
 Pex Ends7
 Press5
 PVC10-11
 SS Cross Handles6
 SS Thumb Grip Handles4
 Stainless Steel5, 39-41
 Standard Port5-7
 Tee Handles4
 UL/FM4-5
 Uni-Flange7
 UPC4
 With Waste Drain7
 Blind Flanges56

Boiler Drains

Aztec22
 Brass21
 Bolt & Gasket Sets57
 Bolts57, 58

Butterfly Valves

B1 - PVC Wafer Style61
 B1 - Parts61
 B5 - Wafer Style62
 B5 - Lug Style62
 B5 - Parts63
 B6 - Wafer Style64
 B6 - Lug Style64
 B6 - Parts65
 B7 - Wafer Style65
 Butterfly Valve Part Breakdown60

C Carbon Steel Ball Valves

Carbon Steel Valves Part Breakdown38
 Flanged39
 Mounting Pad39, 40, 42
 Socket Weld42
 Threaded40, 42
 Three Piece42
 Two Piece39, 40

ITEM NAME PAGE NUMBER

C (continued)
Cast Iron Check Valves
 AWWA53
 IBBM52
 Lever & Weight53
 Resilient Seat52, 53
 UL/FM53
 Wafer54
 Cast Iron Flanges56

Cast Iron Gate Valves
 AWWA46, 48, 51
 Flanged46-51
 Flanged X MJ46, 48
 IBBM49-51
 Mechanical Joint46
 NRS46-50
 OS&Y49-51
 Resilient Wedge46-48, 51
 Ring Tite47, 48
 Rising Stem49-51
 Threaded47, 49-50
 UL/FM51
 Cast Iron Globe Valve51

Check Valves
 Brass17
 Bronze17-18
 Inline18-19
 BUNA-N Seat17
 Horizontal Pattern17
 NSF17, 18
 PVC19
 Spring Loaded18
 Stainless Steel43
 Sump Pump19
 Swing17-18
 Y Pattern18
 Circulator Flange Kit34
 Coin Key Valves30
 Companion Flanges56
 Convector Valve29
 CPVC Ball Valve11

D
 Drain Valve30
 Ductile Iron Gate Valves48, 51

E
 Escutcheons & Keys9
 Evaporator Cooler Valve33

F
 Flanges56
 Flange Accessory Kits57
 Flange Kits34
 Float Rod33
 Float Valve33
 Foot Valve18
 Frost Free Sillcock28

G
 Gaskets57

Gas Valves
 1 Piece - CSA/UL8
 2 Piece - CSA/UL8
 Log Lighter - CSA9

Gate Valves
 Angle29
 Compression Ends14
 Cross Handle12-13

ITEM NAME PAGE NUMBER

G (continued)
 Crown Handle12
 Curb Stop Handle13
 Federal Specification13
 Heavy Pattern12-13
 IAPMO12
 NRS12-14
 NSF12
 OS&Y13
 Quick Opening14
 Radiator29
 Rising Stem13
 Stainless Steel43
 Wheel Handle12-14
 With CPVC Stub Outs14

With Drain12
 UL/FM13
Globe Valves
 Hard Seat15
 Long Bonnet15
 Soft Seat15
 Stainless Steel43
 Stop & Waste20
 Stops20

Garden Valve
 Aztec22
 Brass27

H
 Hose Bibb22, 24-26

I
 Inline Check Valve18-19

L
 Log Lighters - CSA9
 Loose Key Valve24

M
 Meter Valve33
 MJ Accessory Sets58

N
No Kink
 Valve24
 Hose Bibb24-25

O
 Oil Barrel Faucet34
 Oil Tank Valve34
 Operating Nuts59

P
 Press Ball Valve5
 Purge Valve34
 PVC Flanges56

PVC Valves
 Ball Valves10-11
 Check Valves19

Q
 Quick Opening Gate Valve14

R
Radiator Valves
 Angle Valve29-30
 Hot Water Radiator30
 Radiator Gate Valve29
 Steam Radiator29-30

ITEM NAME PAGE NUMBER

S
 Silent Check Valve54
Sillcocks

Aztec23
 Brass27
 Frost Free28
 With Pex Ends28
 With Vacuum Breaker27
 Slip Nuts29
 Spring Loaded Check Valve18

Stainless Steel Ball Valves
 Flanged39
 Mounting Pad39-41
 One Piece39
 Socket Weld41
 Stainless Steel Valves Part Breakdown38
 Threaded39-41
 Three Piece41
 Two Piece39, 40
 Stainless Steel Check Valve43
 Stainless Steel Gate Valve43
 Stainless Steel Globe Valve43
 Stainless Steel Y Strainer43
 Steam Valves29-30

Stop Valves
 Brass20
 Globe20
 Sump Pump Check Valve19

Supply Valves
Multi Turn
 Angle31
 Compression31
 Dual Compression31
 Pex Compression31
 Straight31

Quarter Turn- Oval Handles
 Angle32
 Compression32
 Dual Compression32
 Pex Compression32
 Straight32
 Swing Check Valve17-18

T
 T-Wrench58

V
Vacuum Breakers
 Aztec23-24
 Brass22
 Chrome22

W
 Wafer Check Valve54
 Water Heater Drain Valve30
 Wheel Handles59

Y
Y Strainers
 Bronze16
 Cast Iron55
 Stainless Steel43

Certifications & Approvals

Committed to Quality

Matco-Norca is committed to maintaining a high standard of quality for all the products we offer. Most products in this catalog are labeled with a designated approval or certification code. Below is a brief description of these approvals.



ADA **American Disabilities Act** — Protecting the rights of people with physical or mental disabilities.



ANSI **American National Standards Institute** — Organization that coordinates work among U.S. Standards writing groups; Works in conjunction with other groups such as ISO, ASME, ASTM, etc.



ASME **American Society of Mechanical Engineers** — Develops standards and testing criteria for finished products.



ASSE **American Society of Sanitary Engineering** — Develops standards and qualifies products for plumbing and sanitary installations.



ASTM **American Society for Testing Materials** — Develops standards for materials, products, systems and services.



AWWA **American Water Works Association** — Promotes public health through improvement of water quality. Develops standards for valves, fittings and equipment.



CSA **Canadian Standards Association** — Develops standards, tests and qualifies products used in gas lines and gas appliance installations.



FM **Factory Mutual** — Develops standards and qualifies products for use by the general public.



ISO **International Standards Association** — A worldwide process control organization. An internationally recognized certification for manufacturers that comply with high standards of quality control. Developed standards ISO-9000 through ISO-9004



MSS **Mechanics Standardization Society of the Valves & Fittings Industry, Inc.** — A committee of manufacturers that develops technical codes and standards for the valve & fitting industry.



SDWA **The Safe Drinking Water Act** — Is the main federal law that ensures the quality of Americans' drinking water. Under SDWA, EPA sets standards for drinking water quality and oversees the states, localities, and water suppliers who implement those standards. Weighted average lead content of water contact components must be 0.25% or less.



NSF **NSF International** — An organization committed to public health that writes standards and certifies products for food, water and consumer products.



UL **Underwriter's Laboratory** — Tests and qualifies valve and fittings products under UL standards for safety.



UPC **Uniform Plumbing Code** — Developed by the International Association of Plumbing and Mechanical Officials to govern the installation and inspection of plumbing systems as a means of promoting the public's health, safety and welfare.



USC **University of Southern California** — Foundation for Cross-Connection Control and Hydraulic Research that lists approved backflow prevention assemblies.

Ball Valves - Full Port



757

Ball Valve - Full Port - Forged Brass - UL/FM Certified 1/4" - 2"

Lead Free Version Available

CSA Approved - 1/4" - 2"

1/4" - 2" - 150 SWP 600 WOG 2-1/2" - 4" - 125 SWP 400 WOG

IPS

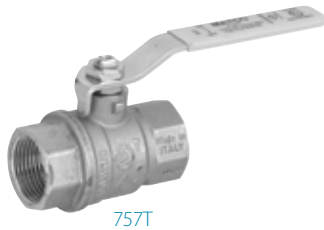

757T

MATCO-NORCA MODEL NUMBER	SIZE	CARTON QUANTITIES INNER	MASTER
757T01	1/4"	12	144
757T02	3/8"	12	144
757T03	1/2"	12	144
757T04	3/4"	10	70
757T05	1"	10	60
757T06	1-1/4"	6	36
757T07	1-1/2"	4	24
757T08	2"	4	6
757T09	2-1/2"	2	6
757T10	3"	2	4
757T11	4"	2	2



759

Ball Valve - Full Port - Forged Brass

Lead Free Version Available

CSA Approved - 1/2" - 2" IPS Only

1/4" - 2" - 150 SWP 600 WOG 2-1/2" - 4" - 100 SWP 600 WOG

IPS

C x C

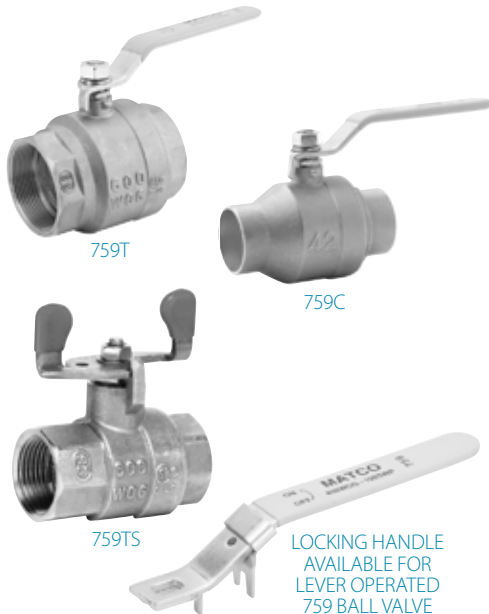

759T

759C

759TS

LOCKING HANDLE AVAILABLE FOR LEVER OPERATED 759 BALL VALVE

MATCO-NORCA MODEL NUMBER	IPS	C x C	SIZE	CARTON QUANTITIES INNER	MASTER
759T01	-	-	1/4"	15	120
759T02	-	-	3/8"	15	120
759T03	-	759C03	1/2"	15	120
759T04	-	759C04	3/4"	10	60
759T05	-	759C05	1"	8	48
759T06	-	759C06	1-1/4"	4	24
759T07	-	759C07	1-1/2"	2	24
759T08	-	759C08	2"	2	12
759T09	-	759C09	2-1/2"	2	6
759T10	-	759C10	3"	1	4
759T11	-	759C11	4"	1	2

Also Available with Tee Handle: 1/4" - 1"

759T01T	-	-	1/4"	12	144
759T03T	-	759C03T	1/2"	15	120
759T04T	-	759C04T	3/4"	10	60
-	-	759C05T	1"	8	48

Also Available with Stainless Steel Thumb Grip Handle: 1/2" - 1-1/4"

Handles Are Not Interchangeable.

759T03TS	-	759C03TS	1/2"	15	120
759T04TS	-	759C04TS	3/4"	10	80
759T05TS	-	759C05TS	1"	8	48
759T06TS	-	-	1-1/4"	4	24

759MF

Ball Valve - Full Port - Forged Brass - MIP X FIP

600 WOG

Lead Free Version Available

With Tee Handle



759MF0001T

759MF0001T	1/8" X 1/4"	12	144
759MF00T	1/8" X 1/8"	12	144
759MF01T	1/4" X 1/4"	12	144

Ball Valves - Full Port & Standard Port



759PLF

Lead Free Press Ball Valve - Full Port - Forged Brass

150 SWP 600 WOG

MATCO-NORCA MODEL NUMBER	SIZE	CARTON QUANTITIES INNER	CARTON QUANTITIES MASTER
759P03LF	1/2"	15	120
759P04LF	3/4"	10	60
759P05LF	1"	8	48
759P06LF	1-1/4"	4	24
759P07LF	1-1/2"	2	24
759P08LF	2"	2	12
759P09LF	2-1/2"	2	6
759P10LF	3"	2	4
759P11LF	4"	1	2

758

Ball Valve - Full Port - Forged Brass - Made In Italy

1/2" - 2" - 150 SWP 600 WOG

C x C

MATCO-NORCA MODEL NUMBER	SIZE	CARTON QUANTITIES INNER	CARTON QUANTITIES MASTER
758C03	1/2"	10	120
758C04	3/4"	5	60
758C05	1"	4	48
758C06	1-1/4"	4	32
758C07	1-1/2"	2	24
758C08	2"	2	16

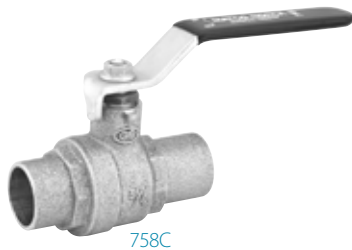

755

Ball Valve - Full Port - Forged Brass - Heavy Duty - Made In Italy

1/4" - 2" - 150 SWP 600 WOG

Nickel Plated

IPS

MATCO-NORCA MODEL NUMBER	SIZE	CARTON QUANTITIES INNER	CARTON QUANTITIES MASTER
755T01	1/4"	10	150
755T02	3/8"	10	120
755T03	1/2"	20	120
755T04	3/4"	12	60
755T05	1"	10	30
755T06	1-1/4"	4	20
755T07	1-1/2"	4	16
755T08	2"	2	6
755T09	2-1/2"	1	5
755T10	3"	1	5
755T11	4"	1	4

2-1/2" - 4" - 100 SWP 400 WOG

UL/FM Certified 1/2" - 2"

760

Ball Valve - Standard Port - One Piece - 316 Stainless Steel

1/4" - 1-1/4" - 1000 WOG

IPS

MATCO-NORCA MODEL NUMBER	SIZE	CARTON QUANTITIES INNER	CARTON QUANTITIES MASTER
760T01	1/4"	60	250
760T02	3/8"	40	160
760T03	1/2"	20	80
760T04	3/4"	10	40
760T05	1"	10	40
760T06	1-1/4"	5	20
760T07	1-1/2"	4	16
760T08	2"	2	8



Ball Valves - Full Port & Standard Port



754N

Ball Valve - Full Port - Forged Brass

1/4" - 2" - 150 SWP 600 WOG 2-1/2" - 4" - 100 SWP 400 WOG
Nickel Plated

IPS

MATCO-NORCA MODEL NUMBER	SIZE	CARTON QUANTITIES INNER	CARTON QUANTITIES MASTER
754T01N	1/4"	30	120
754T02N	3/8"	30	120
754T03N	1/2"	15	120
754T04N	3/4"	10	90
754T05N	1"	6	60
754T06N	1-1/4"	6	36
754T07N	1-1/2"	4	24
754T08N	2"	2	16
754T09N	2-1/2"	1	8
754T10N	3"	1	6
754T11N	4"	1	4

Also Available with Stainless Steel Cross Handle - IPS Only

754T05NX	1"	5	60
----------	----	---	----



752N

Ball Valve - Standard Port - Forged Brass

Lead Free Version Available

150 SWP 400 WOG

IPS

C x C

MATCO-NORCA MODEL NUMBER	SIZE	CARTON QUANTITIES INNER	CARTON QUANTITIES MASTER
752T01N	1/4"	6	240
752T02N	3/8"	6	240
752T03N	1/2"	6	120
752T04N	3/4"	6	120
752T05N	1"	6	60
752T06N	1-1/4"	2	30
752T07N	1-1/2"	2	30
752T08N	2"	2	24
752T09N	2-1/2"	1	12
752T10N	3"	1	8
752T11N	4"	1	6

Also Available with Stainless Steel Cross Handle - IPS Only

752T03NX	1/2"	10	100
752T04NX	3/4"	10	100

300BV

Long Bonnet Brass Ball Valve - Full Port

Lead Free Version Available

600 WOG



300LC3BV	1/2" C x C	6	72
300LT3BV	1/2" IPS	6	72
300LC4BV	3/4" C x C	6	72
300LT4BV	3/4" IPS	6	72

Ball Valves - Full Port & Standard Port



752CMP

752CMP

Ball Valve - Standard Port - Forged Brass

Lead Free Version Available
400 WOG

With Compression Ends For Copper Tube Pipe

MATCO-NORCA MODEL NUMBER	SIZE	CARTON QUANTITIES INNER	CARTON QUANTITIES MASTER
752CMP3	1/2" nominal	25	100
752CMP4	3/4" nominal	15	60
752CMP5	1" nominal	10	40



752TUF



752CUF

752UF

Ball Valve - Full Port - Uni-Flange With Gasket, 2 Bolts & 2 Nuts

400 WOG

IPS x Flange

Copper x Flange

MATCO-NORCA MODEL NUMBER	SIZE	CARTON QUANTITIES INNER	CARTON QUANTITIES MASTER
752T04UF	3/4"	1	24
752T05UF	1"	2	18
752T06UF	1-1/4"	1	12
752T07UF	1-1/2"	1	10



754DT



754DC

754D

Ball Valve - Full Port - Cast Brass - With Waste Drain

Lead Free Version Available
400 WOG

IPS

C x C

MATCO-NORCA MODEL NUMBER	SIZE	CARTON QUANTITIES INNER	CARTON QUANTITIES MASTER
754DT3	1/2"	20	80
754DT4	3/4"	10	40
754DT5	1"	4	16
754PCAP	1/2" - 1"	1	500

Drain Cap



754PX03LF



754PXDE04LF

754PXL

Lead Free Ball Valve - Full Port - Forged Brass - Pex Barb Ends

600 WOG

Max 50 PSI @ 200° F

MATCO-NORCA MODEL NUMBER	SIZE	CARTON QUANTITIES INNER	CARTON QUANTITIES MASTER
754PX03LF	1/2" x 1/2" PEX	10	100
754PX04LF	3/4" x 3/4" PEX	10	100
754PX05LF	1" x 1" PEX	8	48
With Waste Drain & Drop Ear			
754PXDE03LF	1/2" x 1/2" PEX	8	80
754PXDE04LF	3/4" x 3/4" PEX	8	80
754PXDE05LF	1" x 1" PEX	4	40



755MF



755MFZ

755MF

Ball Valve - Male X Female - Cast Bronze

Lead Free Version Available
150 SWP 600 WOG Test Cock

With Lever Handle

MATCO-NORCA MODEL NUMBER	SIZE	CARTON QUANTITIES INNER	CARTON QUANTITIES MASTER
755MF00	1/8" MIP x 1/8" FIP	12	144
755MF0	1/8" MIP x 1/4" FIP	12	144
755MF1	1/4" MIP x 1/4" FIP	12	144

With Slotted Screw

755MFZ0	1/8" MIP x 1/4" FIP	50	200
755MFZ1	1/4" MIP x 1/4" FIP	20	200

Gas Valves

Image	SP	UL	MATCO-NORCA MODEL NUMBER	SIZE	CARTON QUANTITIES	
					INNER	MASTER
 58LGA			58LGA	Gas Ball Valve - 1/2 PSIG And 5G - Two Piece		
			FIP x FIP			
			58LGA3N	1/2"	12	120
			58LGA4N	3/4"	12	120
			58LGA5N	1"	10	60

 58LGA			58LGA	Gas Ball Valve - 1/2 PSIG And 5G - Two Piece		
			FIP x Flare			
			58LGA32	1/2" FIP x 3/8" FL	12	144
			58LGA33	1/2" FIP x 1/2" FL	12	144
			58LGA39	1/2" FIP x 9/16" - 24	12	144
			58LGA4	3/4" FIP x 15/16" - 24	12	144







 58LGA			58LGA	Gas Ball Valve - 1/2 PSIG And 5G - Two Piece		
			Flare x Flare			
			58LGA2	3/8" O.D. x 3/8" O.D.	12	144
			58LGA3	1/2" O.D. x 1/2" O.D.	12	144

 59LGA			59LGA	Gas Ball Valve - 1/2 PSIG And 5G - Made In Italy - One Piece		
			FIP x FIP			
			59LGA2	3/8"	1	100
			59LGA3	1/2"	12	96
			59LGA4	3/4"	20	80

 59LGA			59LGA	Gas Ball Valve - 1/2 PSIG And 5G - Made In Italy - One Piece		
			FIP x Flare			
			59LGA32	1/2" FIP x 3/8" FL	1	144
			59LGA33	1/2" FIP x 1/2" FL	12	144
			59LGA34	3/4" FIP x 1/2" FL	1	1
			59LGA39	1/2" FIP x 9/16" - 24	12	144

 59LGA			59LGA	Gas Ball Valve - 1/2 PSIG And 5G - Made In Italy - One Piece		
			Flare x Flare			
			59LGA2	3/8" O.D. x 3/8" O.D.	1	100
			59LGA3	1/2" O.D. x 1/2" O.D.	12	144
			59LGA4	5/8" O.D. x 5/8" O.D.	1	100

Log Lighter Valves & Accessories

SP	58ST	MATCO-NORCA MODEL NUMBER	SIZE	CARTON QUANTITIES	
				INNER	MASTER
Log Lighter Valves					
Valve Only					
	58-S03	58-S03	1/2" Straight Valve	15	120
	58-A03	58-A03	1/2" Angle Valve	15	120
Straight Valve - Complete Kits Include Valve, Escutcheon And 3" Key					
	58-STR03	58-STR03	1/2" With Chrome Plated Escutcheon & Key	1	25
	58-STR03P	58-STR03P	1/2" With Polished Brass Escutcheon & Key	1	25
Angle Valve - Complete Kits Include Valve, Escutcheon And 3" Key					
	58-ANG03	58-ANG03	1/2" With Chrome Plated Escutcheon & Key	1	25
	58-ANG03P	58-ANG03P	1/2" With Polished Brass Escutcheon & Key	1	25

SP	58	MATCO-NORCA MODEL NUMBER	SIZE	CARTON QUANTITIES	
				INNER	MASTER
Log Lighter Valve - Escutcheons & Keys					
Escutcheons					
	58-300BN	58-300BN	Flat Brushed Nickel	1	1
	58-300PBD	58-300PBD	Domed Polished Brass	12	72
	58-300BND	58-300BND	Domed Brushed Nickel	1	1
	58-300SND	58-300SND	Domed Satin Nickel	20	72
	58-300CP	58-300CP	Flat Chrome Plated	20	120
	58-300PB	58-300PB	Flat Polished Brass	20	120
Keys					
	58-200CP	58-200CP	3" Chrome Plated for 1/4" Stem	1	400
	58-208CP	58-208CP	8" Chrome Plated for 1/4" Stem	1	400
	58-208PB	58-208PB	8" Polished Brass for 1/4" Stem	1	180
	58-212PB	58-212PB	12" Polished Brass for 1/4" Stem	20	120
	58-208BN	58-208BN	8" Brushed Nickel for 1/4" Stem	1	400
	58-212BN	58-212BN	12" Brushed Nickel for 1/4" Stem	20	100
	58-200SN	58-200SN	3" Satin Nickel for 1/4" Stem	1	1
	58-208SN	58-208SN	8" Satin Nickel for 1/4" Stem	50	400
	58-212SN	58-212SN	12" Satin Nickel for 1/4" Stem	20	100

Log Lighter Valves

White PVC Ball Valves & Gray PVC Ball Valves



NSF **770** **Sch. 40 PVC Ball Valve - NSF - Solvent & Threaded - PTFE Seats**

150 PSI @ 73° F
Fits Both Schedule 40 & 80 Pipe

SOLVENT	THREADED	SIZE	CARTON QUANTITIES INNER	MASTER
770S03	770T03	1/2"	1	100
770S04	770T04	3/4"	1	100
770S05	770T05	1"	1	50
770S06	770T06	1-1/4"	1	50
770S07	770T07	1-1/2"	1	50
770S08	770T08	2"	1	20
770S09	770T09	2-1/2"	1	12
770S10	770T10	3"	1	12
770S11	770T11	4"	1	6

See 770N Below for 6" PVC Ball Valve.



770N **Sch. 40 PVC Ball Valve - Solvent & Threaded - PTFE Seats**

150 PSI @ 73° F
Fits Both Schedule 40 & 80 Pipe - Economy Pattern

SOLVENT	THREADED	SIZE	CARTON QUANTITIES INNER	MASTER
770S03N	770T03N	1/2"	10	100
770S04N	770T04N	3/4"	10	100
770S05N	770T05N	1"	10	50
770S06N	770T06N	1-1/4"	5	50
770S07N	770T07N	1-1/2"	5	50
770S08N	770T08N	2"	5	20
770S09N	770T09N	2-1/2"	1	12
770S10N	770T10N	3"	1	12
770S11N	770T11N	4"	1	6
770S13N	-	6"	1	5

Sizes 2-1/2" - 6" Come with Lever Handles.



NSF **770G** **Sch. 80 PVC Ball Valve - NSF - Solvent & Threaded - PTFE Seats**

150 PSI
Fits Both Schedule 40 & 80 Pipe

SOLVENT	THREADED	SIZE	CARTON QUANTITIES INNER	MASTER
770S03G	770T03G	1/2"	1	100
770S04G	770T04G	3/4"	1	100
770S05G	770T05G	1"	1	50
770S06G	770T06G	1-1/4"	1	50
770S07G	770T07G	1-1/2"	1	50
770S08G	770T08G	2"	1	20
770S09G	770T09G	2-1/2"	1	12
770S10G	770T10G	3"	1	12
770S11G	770T11G	4"	1	6

PVC & CPVC Ball Valves



773S

773

PVC Ball Valve - Single Union - Solvent & Threaded - PTFE Seats

150 PSI

SOLVENT

773S07

773S08

THREADED

773T07

773T08

SIZE

1-1/2"

2"

CARTON QUANTITIES

INNER

MASTER

1

1

48

24



772ST

772ST

PVC Ball Valve - True Union - Solvent & Threaded Ends - PTFE Seats

Both Solvent & Threaded Ends In Box

772ST03

772ST04

772ST05

772ST06

772ST07

772ST08

1/2"

3/4"

1"

1-1/4"

1-1/2"

2"

1

1

1

1

1

1

72

60

45

24

16

12

See Below for 3"- 4" True Union Ball Valves.

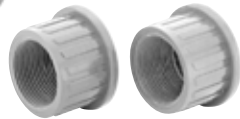

IPS & SLIP ENDS



772S

772

PVC Ball Valve - True Union - Solvent Or Threaded Ends - PTFE Seats

Solvent or Threaded Ends In Box

150 PSI

SOLVENT

772S10

772S11

THREADED

772T10

772T11

3"

4"

1

1

6

1



772T



771

CPVC Ball Valve - NSF Approved - PTFE Seats

100 PSI @ 180° F

SOLVENT

771S03

771S04

771S05

771S06

771S07

771S08

1/2"

3/4"

1"

1-1/4"

1-1/2"

2"

1

1

5

1

1

1

100

100

40

100

48

24



771S

Gate Valves



514

MATCO-NORCA MODEL NUMBER

Gate Valve - Full Port - Cast Brass - Solid Wedge

SIZE **CARTON QUANTITIES**
INNER **MASTER**

125 SWP 200 WOG

Lead Free Version Available

Only Available in Standard

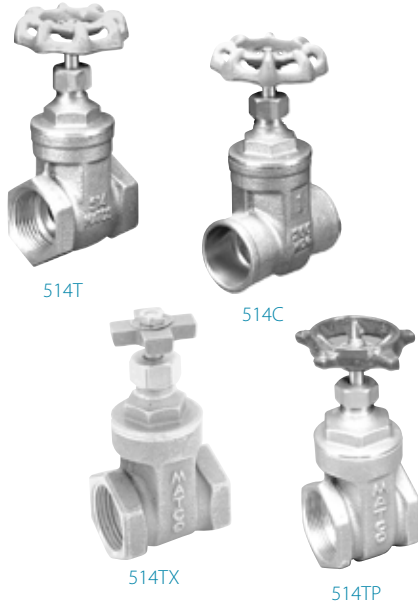

Wheel Handle IPS	Wheel Handle C x C	Cross Handle IPS	Crown Handle IPS	SIZE	CARTON QUANTITIES INNER	MASTER
514T01	-	-	-	1/4"	10	120
514T02	-	-	-	3/8"	10	120
514T03	514C03	514T03X	514T03P	1/2"	10	120
514T04	514C04	514T04X	514T04P	3/4"	10	80
514T05	514C05	514T05X	514T05P	1"	5	60
514T06	514C06	514T06X	514T06P	1-1/4"	5	40
514T07	514C07	514T07X	514T07P	1-1/2"	5	30
514T08	514C08	514T08X	514T08P	2"	2	24
514T09	514C09	514T09X	514T09P	2-1/2"	1	10
514T10	514C10	514T10X	514T10P	3"	1	6
514T11	514C11	514T11X	514T11P	4"	1	4

Replacement Handles Of Each Type Are Available.

503

Gate Valve - Full Port - Bronze - Heavy Pattern

Lead Free Version Available

150 SWP 300 WOG

MSS-SP-80

IPS Only



503T

Model	SIZE	CARTON QUANTITIES INNER	MASTER
503T03	1/2"	10	100
503T04	3/4"	6	60
503T05	1"	5	40
503T06	1-1/4"	5	30
503T07	1-1/2"	4	24
503T08	2"	4	16
503T09	2-1/2"	2	8
503T10	3"	1	6
503T11	4"	1	4



517

Gate Valve With Drain - Cast Brass - Non Rising Stem

125 SWP 200 WOG

IPS

C x C

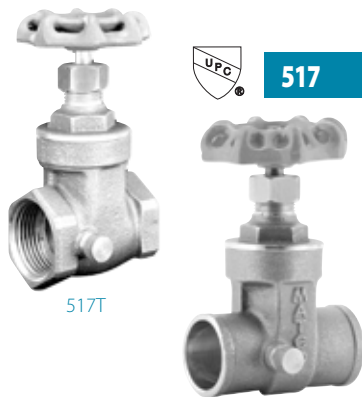

517T

517C

Model	Model	SIZE	CARTON QUANTITIES INNER	MASTER
517T03	517C03	1/2"	10	120
-	517C04	3/4"	10	90
517T05	517C05	1"	5	60

Brass & Bronze Gate Valves

Bronze Gate Valves With Federal Specifications



501T

501 **Gate Valve - OS&Y - Rising Stem - Bronze B62**

**MATCO-NORCA
MODEL NUMBER**

SIZE

**CARTON QUANTITIES
INNER MASTER**

175 CWP

IPS Only

501T04	3/4"	6	60
501T05	1"	16	48
501T06	1-1/4"	12	36
501T07	1-1/2"	2	8
501T08	2"	1	6

511 **Gate Valve - Federal Specification 54 Class A Type 1- Non Rising Stem - Bronze B62**



511T



511C

150 SWP 300 WOG

MSS-SP-80

IPS

C x C

511T03	511C03	1/2"	10	80
511T04	511C04	3/4"	10	60
511T05	511C05	1"	5	40
511T06	511C06	1-1/4"	5	30
511T07	511C07	1-1/2"	4	24
511T08	511C08	2"	2	12

512 **Gate Valve - Federal Specification 54 Class A Type 1- Rising Stem - Bronze B62**



512T



512C

150 SWP 300 WOG

MSS-SP-80

Lead Free Version Available

Only Available in Standard

IPS

C x C

512T03	512C03	1/2"	1	80
512T04	512C04	3/4"	1	60
512T05	512C05	1"	1	40
512T06	512C06	1-1/4"	1	30
512T07	512C07	1-1/2"	1	24
512T08	512C08	2"	1	12
512T09	-	2-1/2"	1	8
512T10	-	3"	1	4

513 **Gate Valve - Full Port - Heavy-Duty - Non Rising Stem - Bronze B62**



513T



513TX



513CS

Lead Free Version Available

125 SWP 200 WOG

MSS-SP-80

IPS Only

Wheel Handle

Cross Handle

Curb Stop Handle

513T04	-	-	3/4"	5	50
513T05	-	-	1"	5	40
513T06	-	-	1-1/4"	4	24
513T07	-	-	1-1/2"	4	24
513T08	513T08X	513T08CS	2"	1	6
-	513T09X	-	2-1/2"	1	10
-	513T10X	-	3"	1	6

Replacement Handles Of Each Type Are Available.

Gate Valves



519T

ANSI

519

Gate Valve - Cast Brass - Non Rising Stem

Lead Free Version Available

200 WOG

MSS-SP-92

With Compression Ends For Copper Tube Pipe

MATCO-NORCA MODEL NUMBER	SIZE	CARTON QUANTITIES	
		INNER	MASTER
519T03	1/2" nominal	10	120
519T04	3/4" nominal	10	90
519T05	1" nominal	5	60



519TP

ANSI

519TP

Gate Valve - Cast Brass - Compression With CPVC Stub-Outs

Lead Free Version Available

200 WOG

MATCO-NORCA MODEL NUMBER	SIZE	CARTON QUANTITIES	
		INNER	MASTER
519T03TP	1/2"	12	72
519T04TP	3/4"	10	90

730

Quick Opening Gate Valve - Without Spring - Cast Bronze - Made In Italy

125 SWP 200 WOG

IPS



730T

MATCO-NORCA MODEL NUMBER	SIZE	CARTON QUANTITIES	
		INNER	MASTER
730T03	1/2"	20	100
730T04	3/4"	20	100
730T05	1"	10	50
730T06	1-1/4"	10	50
730T07	1-1/2"	6	30
730T08	2"	4	20
730T09	2-1/2"	2	12
730T10	3"	2	10
730T11	4"	1	5

Globe Valves



200TLF

200LF

Lead Free Globe Valve - Brass - Hard Seat

MATCO-NORCA MODEL NUMBER	SIZE	CARTON QUANTITIES	
		INNER	MASTER
125 PSI			
IPS			
200T02LF	3/8"	10	100
200T03LF	1/2"	10	100
200T04LF	3/4"	5	60
200T05LF	1"	5	40
200T06LF	1-1/4"	5	30
200T07LF	1-1/2"	4	24
200T08LF	2"	2	16

240T

Angle Control Valve - Globe Pattern - Brass - Soft Seat - Cross Handle

Lead Free Version Available

125 PSI

IPS



240T

240T04	3/4"	8	40
240T05	1"	4	24
240T06	1-1/4"	2	10
240T07	1-1/2"	2	10
240T08	2"	2	10

240H

Angle Control Valve - Globe Pattern - Brass - Soft Seat - Bronze Wheel Handle

Lead Free Version Available

125 PSI

IPS



240TH

240T08H	2"	2	24
---------	----	---	----

200L/200AL

Globe Valve - Long Bonnet - Brass - Soft Seat

Lead Free Version Available

125 PSI

Straight Pattern



200LT



200ALC

200LT3	1/2" IPS	12	72
200LT4	3/4" IPS	12	72
200LC3	1/2" C x C	12	72
200LC4	3/4" C x C	12	72
Angle Pattern			
200ALT3	1/2" IPS	12	72
200ALC3	1/2" C x C	12	72

Bronze Y Strainers

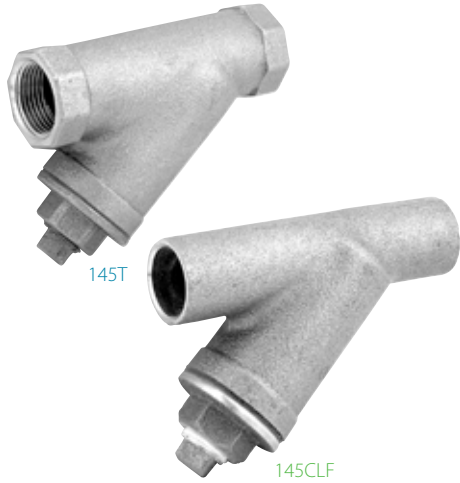



Bronze Y Strainers

145	MATCO-NORCA MODEL NUMBER			SIZE	CARTON QUANTITIES	
	Y Strainer - Cast Bronze - With Brass Plug - 18 Mesh Stainless Steel Screen		INNER		MASTER	
	150 SWP	300 WOG				
	Lead Free Version Available	Lead Free Only				
	IPS	C x C	Size	Tap & Plug Size		
	145T01	-	1/4"	1/8"	12	48
	145T02	-	3/8"	1/8"	12	48
	145T03	145C03LF	1/2"	1/4"	12	48
	145T04	145C04LF	3/4"	1/4"	8	48
	145T05	145C05LF	1"	3/8"	8	32
	145T06	145C06LF	1-1/4"	3/8"	8	24
	145T07	145C07LF	1-1/2"	1/2"	2	16
	145T08	145C08LF	2"	1/2"	2	8
	145T09	-	2-1/2"	1-1/4"	1	6
	145T10	-	3"	1-1/2"	1	4

Replacement Screens Available.

Swing Check Valves - Brass & Bronze

ANSI	521	MATCO-NORCA MODEL NUMBER	SIZE	CARTON QUANTITIES	
				INNER	MASTER
Swing Check Valve - Cast Brass - Brass Seat					
200 WOG					
Lead Free Version Available					
IPS					
 521T		521T02	-	12	120
		521T03	3/8"	12	120
		521T04	1/2"	10	80
		521T05	3/4"	5	60
		521T06	1"	5	40
		521T07	1-1/4"	5	30
		521T08	1-1/2"	2	24
		521T08	2"		
 521CLF		521C03LF	3/8"		
		521C04LF	1/2"		
		521C05LF	3/4"		
		521C06LF	1"		
		521C07LF	1-1/4"		
	521C08LF	1-1/2"			
	521C08LF	2"			
		521C09	2-1/2"	1	15
		521C10	3"	1	6
		521C11	4"	1	6

ANSI	521N	MATCO-NORCA MODEL NUMBER	SIZE	CARTON QUANTITIES	
				INNER	MASTER
Swing Check Valve - Cast Brass - BUNA-N Seat					
Lead Free Version Available					
200 WOG					
IPS					
 521N		521N02	3/8"	1	120
		521N03	1/2"	10	120
		521N04	3/4"	10	80
		521N05	1"	5	60
		521N06	1-1/4"	1	40
		521N07	1-1/2"	5	20
		521N08	2"	1	24
		521N09	2-1/2"	1	15
		521N10	3"	1	6
		521N11	4"	1	6

ANSI	530	MATCO-NORCA MODEL NUMBER	SIZE	CARTON QUANTITIES	
				INNER	MASTER
Swing Check Valve - Cast Bronze B62 - Bronze Disc - Horizontal Pattern					
Lead Free Version Available					
150 SWP 300 WOG					
IPS					
 530T		530T02	3/8"	12	120
		530T03	1/2"	12	120
		530T04	3/4"	10	80
		530T05	1"	5	60
		530T06	1-1/4"	5	40
		530T07	1-1/2"	5	30
		530T08	2"	2	24
		530T09	2-1/2"	1	15
		530T10	3"	1	6
		530T11	4"	1	6

Brass & Bronze Check Valves

Check Valves Foot Valve



532T

532	MATCO-NORCA MODEL NUMBER	SIZE	CARTON QUANTITIES	
			INNER	MASTER
Swing Check Valve Y Pattern - Bronze B62				
150 SWP 300 WOG				
IPS				
	532T03	1/2"	10	90
	532T04	3/4"	10	80
	532T05	1"	10	60
	532T06	1-1/4"	5	30
	532T07	1-1/2"	4	24
	532T08	2"	2	16

525 Inline Check Valve - Spring Loaded - Bronze B62 - 1/2 PSI Crack Pressure



525T

**Lead Free
Version
Available**

**Lead Free
Only**

200 WOG				
IPS		CXC		
	525T03	1/2"	10	100
	525T04	3/4"	10	80
	525T05	1"	6	60
	525T06	1-1/4"	4	40
	525T07	1-1/2"	5	30
	525T08	2"	5	20
	525C03LF	1/2"	10	100
	525C04LF	3/4"	10	80
	525C05LF	1"	6	60
	525C06LF	1-1/4"	4	40
	525C07LF	1-1/2"	5	30
	525C08LF	2"	5	20

527LF Lead Free Foot Valve - Stainless Steel Screen - Bronze B62



527LF

200 WOG				
IPS				
	527T03LF	1/2"	1	100
	527T04LF	3/4"	1	80
	527T05LF	1"	1	60
	527T06LF	1-1/4"	1	40
	527T07LF	1-1/2"	1	30
	527T08LF	2"	1	20

PVC Check Valve

Sump Pump Check Valve



523S



523T

523

PVC Inline Check Valve - 304 SS Spring - 1/2 PSI Crack Pressure - One Piece

Max 150 PSI @ 122° F

SOLVENT

THREADED

MATCO-NORCA MODEL NUMBER	SIZE	CARTON QUANTITIES INNER	CARTON QUANTITIES MASTER
523S03	1/2"	1	120
523S04	3/4"	1	120
523S05	1"	1	80
523S06	1-1/4"	1	60
523S07	1-1/2"	1	60
523S08	2"	1	40

529

Sump Pump Check Valve - Flexible Rubber Connections - Stainless Steel Clamps



529

MATCO-NORCA MODEL NUMBER	SIZE	CARTON QUANTITIES INNER	CARTON QUANTITIES MASTER
529-0808	2" x 2"	10	50
529-0706	1-1/2" x 1-1/4"	10	50

Stop Valves - Globe Style

		MATCO-NORCA MODEL NUMBER	SIZE	CARTON QUANTITIES INNER MASTER			
201		Stop Valve - Globe Style - Brass - Soft Seat					
		125 PSI					
		Lead Free Only		Lead Free Version Available			
		IPS	C x C	IPS With Cross Handle			
		201T03LF	201C03LF	201X03	1/2"	12	72
201TLF	201CLF	201T04LF	201C04LF	201X04	3/4"	12	72
							
	201X						
		<i>Replacement Handles Available.</i>					

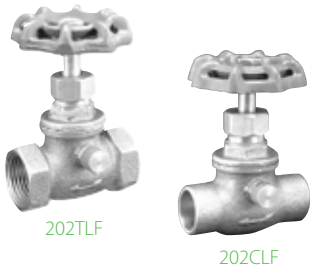

202TLF

202CLF

202LF Stop & Waste Valve - Globe Style - Brass - Soft Seat

125 PSI

IPS	C x C		
202T03LF	202C03LF	1/2"	12
202T04LF	202C04LF	3/4"	12

1/2"
3/4"

12
12

72
72

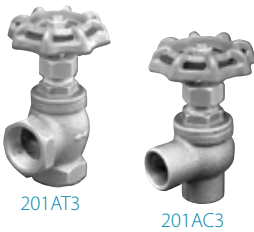

201AT3

201AC3

201A Angle Stop Valve - Globe Style - Brass - Soft Seat

Lead Free Version Available

125 PSI

201AT3	1/2" IPS	12	72
201AC3	1/2" C x C	12	72



201CMPLF

201/202CMLF Lead Free Stop & Waste Valve - Brass Nut & Ferrule

125 PSI

With Compression Ends For Copper Tube Pipe

With Waste Cap

201CMPLF	202CMPLF	1/2" nominal	12	72
201CM4LF	202CM4LF	3/4" nominal	12	72

Brass Boiler Drains - Full Flow

Brass Boiler Drains

205F **Boiler Drain - 3/4" Hose Outlet - Angle Spout - With Stuffing Box**



Lead Free Version Available

125 PSI

MATCO-NORCA MODEL NUMBER	SIZE	CARTON QUANTITIES INNER	CARTON QUANTITIES MASTER
MIP			
205F03*	1/2"	12	72
205F04	3/4"	12	72
* 1/2" MIP & 1/2" SWT Inlet			
FIP			
205FF3	1/2"	12	72
205FF4	3/4"	12	72

205 **Boiler Drain - 3/4" Hose Outlet - With Stuffing Box**



Lead Free Version Available

125 PSI

MATCO-NORCA MODEL NUMBER	SIZE	CARTON QUANTITIES INNER	CARTON QUANTITIES MASTER
MIP			
205TM3*	1/2"	12	72
205TM4	3/4"	12	72
* 1/2" MIP & 1/2" SWT Inlet			
FIP			
205TF3	1/2"	12	72
205TF4	3/4"	12	72
CTS Compression With Nut & Ferrule			
205TR3	1/2"	12	72

205CM **Boiler Drain - 3/4" Hose Outlet - Angle Spout - With Stuffing Box**



125 PSI

MATCO-NORCA MODEL NUMBER	SIZE	CARTON QUANTITIES INNER	CARTON QUANTITIES MASTER
205CM3	1/2" Male Copper Sweat	12	72

204 **Boiler Drain - 3/4" Hose Outlet - Less Stuffing Box**









Lead Free Version Available

125 PSI



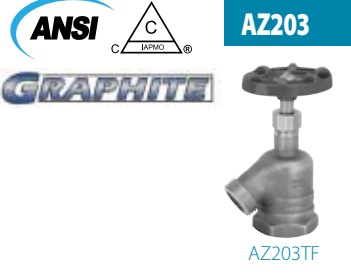







MATCO-NORCA MODEL NUMBER	SIZE	CARTON QUANTITIES INNER	CARTON QUANTITIES MASTER
MIP			
204TM3*	1/2"	12	72
204TM4	3/4"	12	72
204LS3*	Long Shank 1/2" MIP With Locknut	12	72
204LS3P*	Long Shank 1/2" NPT x Chamfer For Cone Connection With Locknut	12	72
* 1/2" MIP & 1/2" SWT Inlet			

Vacuum Breaker & Back Flow Preventers Aztec Low Pressure Valves

	MATCO-NORCA MODEL NUMBER	SIZE	CARTON QUANTITIES INNER MASTER		
 <p>646AS4 646ASC</p>	646AS	Hose Bibb Vacuum Breaker - Brass - With Break-Away Set Screw			
	<p>Lead Free Version Available Conforms To ASSE 1011 Hose Connection</p>				
	646AS4	3/4" Brass Finish	12	144	
	646ASC	3/4" Chrome Plated	12	144	
 <p>BFP-90LF</p>	BFPLF	Lead Free Back Flow Preventer - Brass - With Atmospheric Vent			
	<p>Conforms to ASSE 1012 Max 175 PSI @ 250° F IPS C x C</p>				
	BFP-90-1/2LF	BFP-90-1/2-CLF	1/2" FIP	1	24
	BFP-90-3/4LF	-	3/4" FIP	1	24
 <p>DCV-04LF</p>	DCVLF	Lead Free Dual Check Back Flow Preventer - Brass			
	<p>Conforms to ASSE 1024 Max 175 PSI @ 140° F IPS</p>				
	DCV-04LF		3/4"	1	24
	DCV-05LF		1"	1	24
 <p>AZ646R</p>	AZ646R	Aztec Hose Bibb With Tee Handle - Graphite Packing			
	<p>Lead Free Version Available 125 PSI</p>				
	AZ646R03		Inlet 1/2" MIP	12	72
	AZ646R04		3/4" MIP	12	72
 <p>AZ203TF</p>	AZ203	Aztec Bent Nose Garden Valve With Stuffing Box - Graphite Packing			
	<p>Lead Free Version Available 125 PSI</p>				
	AZ203TF3		Inlet 1/2" FIP	12	72
	AZ203TF4		3/4" FIP	12	72
	AZ203TF5		1" FIP	12	72
 <p>AZ205C034 AZ205TF AZ205TM</p>	AZ205	Aztec Boiler Drain With Stuffing Box - Graphite Packing			
	<p>Lead Free Version Available 125 PSI</p>				
	AZ205C034		3/4" Copper Fitting & 1/2" Copper Sweat	12	72
	AZ205TF3		1/2" FIP	12	72
	AZ205TF4		3/4" FIP	12	72
	AZ205TM3		1/2" MIP	12	72
	AZ205TM4		3/4" MIP	12	72

Aztec Low Pressure Valves

Aztec Low Pressure Valves Sillcocks

	MATCO-NORCA MODEL NUMBER	SIZE	CARTON QUANTITIES	
			INNER	MASTER
  AZ206C034  AZ206T	AZ206 Aztec Sillcock With Stuffing Box - Brass - Graphite Packing			
	 Lead Free Version Available 125 PSI			
	AZ206C034	Inlet 3/4" Copper Fitting & 1/2" Copper Sweat	12	72
	AZ206T03	1/2" FIP	12	72
	AZ206T04	3/4" FIP	12	72
  AZ206T/VB	AZ206/VB Aztec Sillcock With Vacuum Breaker - Brass - Graphite Packing			
	 Lead Free Version Available 125 PSI			
	AZ206T03/VB	1/2" FIP	12	72
	AZ206T04/VB	3/4" FIP	12	72
  AZ206LK	AZ206/LK Aztec Sillcock With Vacuum Breaker - Loose Key - Graphite Packing			
	 Lead Free Version Available 125 PSI			
	AZ206T03LK	1/2" FIP	12	72
	AZ206T04LK	3/4" FIP	12	72

Aztec Low
Pressure Valves

Aztec Low Pressure Valves



AZ207

MATCO-NORCA MODEL NUMBER **SIZE** **CARTON QUANTITIES INNER MASTER**

Aztec No Kink Hose Bibb - Brass - Graphite Packing

Lead Free Version Available

125 PSI



AZ207C04

AZ207TF

AZ207C04

Inlet

3/4" Copper Fitting and
1/2" Copper Sweat

12 72

AZ207TF3

1/2" FIP

12 72

AZ207TF4

3/4" FIP

12 72



AZ207TM

AZ207TR

AZ207TM3

1/2" MIP

12 72

AZ207TM4

3/4" MIP

12 72

AZ207TR3

1/2" CTS Compression
With Nut & Ferrule

12 72



AZ207

Aztec Loose Key Valve - No Kink - Brass - Graphite Packing

Lead Free Version Available

125 PSI



AZ207TFLK

AZ207TMLK

AZ207TF3LK

Inlet

1/2" FIP

12 72

AZ207TF4LK

3/4" FIP

12 72

AZ207TM3LK

1/2" MIP

12 72

AZ207TM4LK

3/4" MIP

12 72



AZ207

Aztec No Kink Valve With Vacuum Breaker - Brass - Graphite Packing

Lead Free Version Available

125 PSI



AZ207TF/VB

AZ207TM/VB

AZ207TF3/VB

Inlet

1/2" FIP

12 72

AZ207TF4/VB

3/4" FIP

12 72

AZ207TM3/VB

1/2" MIP

12 72

AZ207TM4/VB

3/4" MIP

12 72

Hose Bibbs

Ball Valve Hose Bibbs



646R

**MATCO-NORCA
MODEL NUMBER**

646R Hose Bibb - Male - Cast Brass

SIZE

**CARTON QUANTITIES
INNER MASTER**

Lead Free Version Available
125 PSI

	Inlet		
646R03	1/2" MIP & 1/2" SWT x 3/4" Hose	12	72
646R04	3/4" MIP x 3/4" Hose	12	72
646R05	1" MIP x 1" Hose	12	48
P646R03H	Replacement Handle for 1/2" & 3/4"	1	100



646BV

646BV Ball Valve Hose Bibb - Forged Brass - 1/4 Turn - 3/4" Hose Outlet

Lead Free Version Available
125 PSI

	Inlet		
646BV03	1/2" MIP & 1/2" SWT	12	24
646BV04	3/4" MIP	12	24
P646BVC43H	Replacement Handles	1	1000



207TM



207TF



207C

207

No Kink Hose Bibb - 3/4" Hose Outlet

Lead Free Version Available
125 PSI

	MIP	Inlet		
207TM3		1/2"	12	72
207TM4		3/4"	12	72
	FIP			
207TF3		1/2"	12	72
207TF4		3/4"	12	72
	Sweat			
207C04		1/2" Sweat & 3/4" Copper Fitting	12	72







Plumbing Specialty Brass Hose Bibbs

FY	MATCO-NORCA MODEL NUMBER	SIZE	CARTON QUANTITIES	
			INNER	MASTER
Hose Bibb - Brass - Tee Handles				
Lead Free Version Available				
125 PSI				
	FY-675	Chrome Plated Hose Bibb Plain End Outlet 1/2" FIP Inlet - Flanged	12	72
	FY-680	Chrome Plated Hose Bibb 3/4" Hose End Outlet 1/2" FIP Inlet - Flanged	12	72
	FY-681	Chrome Plated Hose Bibb Plain End Outlet 1/2" MIP Inlet - Adj. Flange	12	72
	FY-682	Chrome Plated Hose Bibb 3/4" Hose End Outlet 1/2" MIP Inlet - Adj. Flange	12	72
	FY-685*	Chrome Plated Hose Bibb 3/4" Hose End Outlet 1/2" FIP Inlet	12	72
	FY-690	Chrome Plated Hose Bibb 3/4" Hose End Outlet 1/2" MIP Inlet	12	72
	FY-691	Chrome Plated Hose Bibb Plain End Outlet 1/2" MIP Inlet	12	72
	FY-691PB*	Polished Brass Hose Bibb (not shown) Plain End Outlet 1/2" MIP Inlet	12	72
	FY-692	Rough Brass Hose Bibb Plain End Outlet 1/2" MIP Inlet	12	72
	FY-695	Chrome Plated Hose Bibb 3/4" Hose End Outlet 3/4" MIP Inlet	12	144

*** Only Available in Standard**

Brass Sillcocks Garden Valves

Sillcocks

	MATCO-NORCA MODEL NUMBER		SIZE	CARTON QUANTITIES		
				INNER	MASTER	
 <p>206T 206C</p> 	206		Sillcock - 3/4" Hose Outlet - Brass Body			
	<p>Lead Free Version Available</p> <p>125 PSI</p>					
		FIP	Sweat	Inlet		
		206T03	206C03	1/2"	12	72
		206T04	206C04	3/4"	12	72
 <p>206T03H</p>  <p>206VB</p>  <p>206VB</p>  <p>206HLK</p>	206H		Sillcock - Heavy Pattern - 3/4" Hose Outlet - Brass Body - With Stuffing Box			
	<p>Lead Free Version Available</p> <p>125 PSI</p>					
		FIP		Inlet		
		206T03H		1/2" FIP	12	72
	206T04H		3/4" FIP	12	72	
206VB		Sillcock - With ASSE 1011 Vacuum Breaker				
<p>Lead Free Version Available</p> <p>125 PSI</p>						
	FIP		Inlet			
	206T03VB		1/2" FIP	12	72	
206HLK		Sillcock - Loose Key - Heavy Pattern - Female - 3/4" Hose Outlet				
<p>125 PSI</p>						
	FIP		Inlet			
	206T03HLK		1/2" FIP	12	72	
	206T04HLK		3/4" FIP	12	72	
203		Garden Valve - Bent Nose - Female - 3/4" Hose Outlet				
<p>Lead Free Version Available</p> <p>125 PSI</p>						
	Bent Nose		Inlet			
	203TF3		1/2" FIP	12	72	
	203TF4		3/4" FIP	12	72	
	203TF5		1" FIP	12	72	
	Inverted Nose					
	203IF4		3/4" FIP	12	72	
	Loose Key					
	203TL3		1/2"	12	72	
	203TL4		3/4"	12	72	
	203TL5		1"	12	72	
	Key Only					
	203TLK			1	200	

Frost Free Sillcocks



209

Frost Free Sillcock - 3/4" Hose Outlet

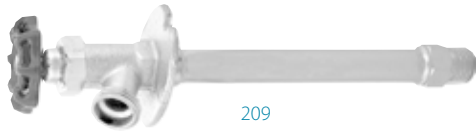

209

**MATCO-NORCA
MODEL NUMBER**

SIZE

**CARTON QUANTITIES
INNER MASTER**

125 PSI
Lead Free Version Available
 1/2" MIP & 1/2" SWT Inlet

Only Available in Standard

209004
209006
209008
209010
209012

Length

4"
6"
8"

1 24
1 24
1 24

209014

10"
12"
14"

1 24
1 24
1 24

209008LK
209010LK
209012LK

Length

8"
10"
12"

1 24
1 24
1 24

3/4" MIP & 1/2" FIP Inlet

Length

209404
209406
209408

4"
6"
8"

1 24
1 24
1 24

209410
209412
209414

10"
12"
14"

1 24
1 24
1 24



209PX

Frost Free Sillcock - Pex - 3/4" Hose Outlet

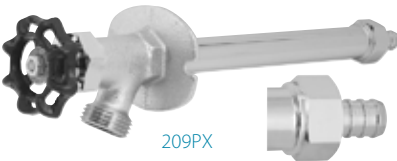

209PX

125 PSI
 1/2" PEX Inlet

209004PX
209006PX
209008PX
209010PX
209012PX

4"
6"
8"
10"
12"

1 24
1 24
1 24
1 24
1 24



212

Frost Free Sillcock - Anti Syphon - 3/4" Hose Outlet



212

Lead Free Version Available

125 PSI
 1/2" MIP & 1/2" SWT Inlet

212004
212006
212008
212010
212012
212014
212KIT - Vacuum Breaker Kit Available.

Length

4"
6"
8"
10"
12"
14"

1 24
1 24
1 24
1 24
1 24
1 24



212PX

Frost Free Sillcock - Pex - Anti Syphon - 3/4" Hose Outlet

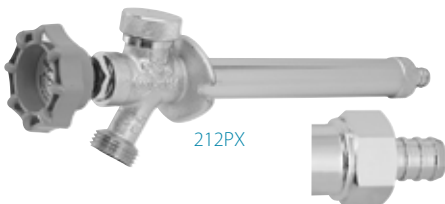

212PX

Lead Free Version Available

125 PSI
 1/2" PEX Inlet

212004PX
212006PX
212008PX
212010PX
212012PX
212014PX

4"
6"
8"
10"
12"
14"

1 24
1 24
1 24
1 24
1 24
1 24

Steam Radiator Angle & Gate Valves Slip Nuts, Convector Valve



BARVY

MATCO-NORCA MODEL NUMBER	SIZE	CARTON QUANTITIES	
		INNER	MASTER
BARVY Steam Radiator Angle Valve - Brass - Heavy Pattern			
BARVY-0500	1/2" FIP With Nut & Tailpiece	10	60
BARVY-0750	3/4" FIP With Nut & Tailpiece	6	48
BARVY-1000	1" FIP With Nut & Tailpiece	4	36
BARVY-1250	1-1/4" FIP With Nut & Tailpiece	2	24
BARVY-1500	1-1/2" FIP With Nut & Tailpiece	2	16



BARV

MATCO-NORCA MODEL NUMBER	SIZE	CARTON QUANTITIES	
		INNER	MASTER
BARV Steam Radiator Angle Valve - Bronze - Heavy Pattern			
BARV-0500	1/2" FIP With Nut & Tailpiece	10	60
BARV-0750	3/4" FIP With Nut & Tailpiece	6	48
BARV-1000	1" FIP With Nut & Tailpiece	4	36
BARV-1250	1-1/4" FIP With Nut & Tailpiece	2	24
BARV-1500	1-1/2" FIP With Nut & Tailpiece	2	18
BARV-2000	2" FIP With Nut & Tailpiece	1	8



NT

MATCO-NORCA MODEL NUMBER	SIZE	CARTON QUANTITIES	
		INNER	MASTER
NT Slip Nuts - Chrome			
NT-100	1" Nut & Tail Piece For BARVY-1000 & BARV-1000	10	100
NT-125	1-1/4" Nut & Tail Piece For BARVY-1250 & BARV-1250	10	100



SGV

MATCO-NORCA MODEL NUMBER	SIZE	CARTON QUANTITIES	
		INNER	MASTER
SGV Steam Radiator Gate Valve - Brass			
SGV-1251	1-1/4" FIP With Nut & Tailpiece	4	24



BSGV

MATCO-NORCA MODEL NUMBER	SIZE	CARTON QUANTITIES	
		INNER	MASTER
BSGV Steam Radiator Gate Valve - Bronze - Heavy Pattern			
BSGV-0750	3/4" FIP With Nut & Tailpiece	6	48
BSGV-1000	1" FIP With Nut & Tailpiece	4	36
BSGV-1250	1-1/4" FIP With Nut & Tailpiece	4	24
BSGV-1500	1-1/2" FIP With Nut & Tailpiece	4	24



BCV

MATCO-NORCA MODEL NUMBER	SIZE	CARTON QUANTITIES	
		INNER	MASTER
BCV Convector Valve - Bronze			
BCV-1250	1-1/4" FIP With FIP Union	2	20

Radiator Valve & Air Valves Drain Valve



AHV

AHV

Angle Hot Water Radiator Valve - Brass

MATCO-NORCA MODEL NUMBER	SIZE	CARTON QUANTITIES	
		INNER	MASTER
AHV-0500	1/2" FIP With Nut & Tailpiece	1	60
AHV-0750	3/4" FIP With Nut & Tailpiece	1	60
AHV-1000	1" FIP With Nut & Tailpiece	4	36
AHV-1250	1-1/4" FIP With Nut & Tailpiece	2	24
AHV-0500C	1/2" SWT With Nut & Tailpiece	1	60
AHV-0750C	3/4" SWT With Nut & Tailpiece	1	60



CK-100



KEY-100



HAV-125

CK/KEY

Coin Key Air Valve

CK-100	Coin Key Air Valve Nickle Plated	1/8"	100	1000
CKU-102	Key Air Valve	1/8"	100	1000
KEY-100	Key For Air Valve	1/8"	100	2000
HAV-125	Auto Vent HW & Steam	1/8"	50	500



AVA-125



AVS-125



ADJ-180

AVA/AVS/ADJ

Chrome Plated Steam Air Valves

AVA-125	1/8" Angle - MIP		12	144
AVS-125	1/8" Straight - MIP		1	144
AVS-250	1/4" Straight - MIP		1	144
AVS-750	3/4" MIP & 1/2" FIP Straight		1	144
ADJ-180	1/8" Angle MIP Adjustable		12	144



205WH4

205WH























Water Heater Drain Valve - Brass - Heavy Pattern



Lead Free Version Available

205WH4	3/4" x 2-1/4" Long 3/4" MIP & 1/2" FIP Inlet		12	72
--------	---	--	----	----

Multi-Turn Supply Valves

		MATCO-NORCA MODEL NUMBER	SIZE	CARTON QUANTITIES INNER MASTER		
  29-1001LF  29-1003PXLF  29-1009LF  29-1019LF  29-1019CPVCLF  29-2001PXLF	29LF	Lead Free Supply Valves - Oval Handle With Compression Outlet - Angle				
			125 PSI			
			29-1001LF	CP 3/8" FIP x 3/8" OD Compression	10	200
			29-1003LF	CP 1/2" FIP x 3/8" OD Compression	10	200
			29-1003PXLF	CP 1/2" PEX x 3/8" OD Compression	10	200
			29-1003BLF	Unplated 1/2" FIP x 3/8" OD Compression	10	200
			29-1009LF	CP 1/2" SWT x 3/8" OD Compression	10	200
			29-1009BLF	Unplated 1/2" SWT x 3/8" OD Compression	10	200
			29-1019LF	CP 5/8" OD Compression x 3/8" OD Compression	10	200
			29-1019BLF	Unplated 5/8" OD Compression x 3/8" OD Compression	10	200
			29-1019CPVCLF	CP 5/8" OD CPVC x 3/8" OD	10	200
			29-2001PXLF	CP 1/2" PEX x 3/8" OD Compression x 3/8" OD Compression	10	200
  29-1004LF  29-1004PXLF  29-1010BLF  29-1010LF  29-1014LF  29-1014CPVCLF  29-1020LF  29-1575LF	29LF	Lead Free Supply Valves - Oval Handle With Compression Outlet - Straight				
			125 PSI			
			29-1002LF	CP 3/8" FIP x 3/8" OD Compression	10	200
			29-1004LF	CP 1/2" FIP x 3/8" OD Compression	10	200
			29-1004PXLF	CP 1/2" PEX x 3/8" OD Compression	10	200
			29-1010LF	CP 1/2" SWT x 3/8" OD Compression	10	200
			29-1010BLF	Unplated 1/2" SWT x 3/8" OD Compression	10	200
			29-1014LF	CP 5/8" OD Compression x 3/8" OD Compression	10	200
			29-1014CPVCLF	CP 5/8" OD CPVC x 3/8" OD Straight Stop	10	200
			29-1020LF	CP 1/2" OD Compression x 3/8" OD Compression	10	200
		29-1575LF	CP 5/8" OD Compression x 5/8" OD Compression	10	200	
  29-1040LF  29-1041LF	29LF	Lead Free Supply Valves - Oval Handle With Compression Outlet With 5" Extension and Bell Escutcheon				
			29-1040LF	CP 1/2" SWT x 3/8" OD Compression - Angle	10	100
			29-1041LF	CP 1/2" SWT x 3/8" OD Compression - Straight	10	100
  29-2001LF  29-2001BLF	29LF	Lead Free Supply Valves Oval - Handle With Dual Compression Outlet - Angle				
			125 PSI			
			29-2001LF	CP 5/8" OD x 3/8" OD x 3/8" OD	10	200
		29-2001BLF	Unplated 5/8" OD x 3/8" OD x 3/8" OD	10	200	

Multi-Turn Supply Valves

Quarter Turn Supply Valves

		MATCO-NORCA MODEL NUMBER	SIZE	CARTON QUANTITIES INNER MASTER		
		26LF	Lead Free Supply Valves - Oval Handle - With Compression Outlet - Angle			
			125 PSI			
		26-1001LF	CP 3/8" FIP x 3/8" OD Compression	10	200	
		26-1003LF	CP 1/2" FIP x 3/8" OD Compression	10	200	
		26-1003PXL	CP 1/2" PEX x 3/8" OD Compression	10	200	
		26-1009LF	CP 1/2" Sweat x 3/8" OD Compression	10	200	
		26-1009BLF	Unplated 1/2" Sweat x 3/8" OD Compression	10	200	
		26-1019LF	CP 5/8" OD Compression x 3/8" OD Compression	10	200	
		26-1019BLF	Unplated 5/8" OD Compression x 3/8" OD Compression	10	200	
		26-1019CPVCLF	CP 5/8" OD CPVC Compression x 3/8" OD Compression	10	200	
		26LF	Lead Free Supply Valves - PEX - Oval Handle - With Compression Outlet - Straight			
			125 PSI			
		26-1002LF	CP 3/8" FIP x 3/8" OD Compression	10	200	
		26-1004LF	CP 1/2" FIP x 3/8" OD Compression	10	200	
		26-1004PXL	CP 1/2" PEX x 3/8" OD Compression	10	200	
		26-1010LF	CP 1/2" Sweat x 3/8" OD Compression	10	200	
		26-1010BLF	Unplated 1/2" Sweat x 3/8" OD Compression	10	200	
		26-1014LF	CP 5/8" OD Compression x 3/8" OD Compression	10	200	
26-1014PVCLF	CP 5/8" OD CPVC Compression x 3/8" OD Compression	10	200			
		26LF	Lead Free Supply Valves - Oval Handle - With Compression Outlet			
			125 PSI	With 5" Extension and Bell Escutcheon		
		26-1041LF	CP 1/2" Sweat x 3/8" OD Compression - Angle	10	100	
26-1040LF	CP 1/2" Sweat x 3/8" OD Compression - Straight	10	100			
		26LF	Lead Free Supply Valves - Oval Handle - With Dual Compression Outlet - Angle			
			125 PSI			
26-2001LF	CP 5/8" OD Compression x 3/8" OD Compression	10	200			
26-2001BLF	Unplated 5/8" OD Compression x 3/8" OD Compression	10	200			
		25LF	Lead Free Supply Valves - Lever Handle - With Compression Outlet - Straight			
25-2000LF	CP Retro-Fit 3/8" OD Captured Nut x 3/8" OD Compression	10	200			

Miscellaneous: Float Valve, Float Rod, Evaporator Cooler Float Valve, Meter Valve



FV-404

FV	MATCO-NORCA MODEL NUMBER		SIZE	CARTON QUANTITIES	
	INNER	MASTER			
Float Valve - Bronze					
Straight Thread Male Inlet - Plain Outlet					
Rod Size					
	FV-303P	1/2"	1/4" x 20"	12	72
	FV-404P	3/4"	1/4" x 20"	6	36
Straight Thread Male Inlet - Straight Thread Male Outlet					
	FV-303	1/2"	1/4" x 20"	1	72
	FV-404	3/4"	1/4" x 20"	6	48
Female Inlet - Plain Outlet					
	FV-505	1"	5/16" x 18"	4	36
	FV-606	1-1/4"	3/8" x 16"	2	20
	FV-707	1-1/2"	3/8" x 16"	2	16
	FV-808	2"	3/8" x 16"	2	12



FR12-1

FR	MATCO-NORCA MODEL NUMBER		Length	Thread Pattern	CARTON QUANTITIES	
	INNER	MASTER				
Float Rod - Brass						
	FR12-1		12"	1/4" - 20	5	500
	FR12-15		12"	5/16" - 18	5	250
	FR12-2		12"	3/8" - 16	1	200

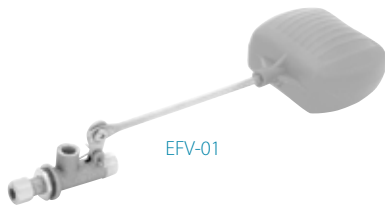

EFV-01

EFV	MATCO-NORCA MODEL NUMBER		SIZE	CARTON QUANTITIES	
	INNER	MASTER			
Evaporator Cooler Float Valve					
	EFV-01		1/4" Compression Inlet x 1/4" FIP Outlet	20	80



434-0404LF



434-0404DLF

434LF	MATCO-NORCA MODEL NUMBER		SIZE	CARTON QUANTITIES	
	INNER	MASTER			
Lead Free Meter Valve - Brass					
Angle Valve - Flare x IPS					
	434-0403LF		3/4" FL x 1/2" IPS	6	36
	434-0404LF		3/4" FL x 3/4" IPS	6	36
	434-0504LF		1" FL x 3/4" IPS	6	24
	434-0505LF		1" FL x 1" IPS	4	24
Angle Valve With Drain - Flare x IPS					
	434-0404D		3/4" FL x 3/4" IPS	6	36
	434-0505D		1" FL x 1" IPS	4	24

Miscellaneous: Oil Tank Valve, Oil Barrel Faucet, Balancing Valves, Circulator Flange Kits

	MATCO-NORCA MODEL NUMBER	SIZE	CARTON QUANTITIES	
			INNER	MASTER
 <p>OTV-100</p> <p>OTV-200</p>	OTV Oil Tank Valve - Brass - Hard Seat			
	OTV-100	1/2" MIP X 3/8" MIP	6	72
	OTV-200	1/2" MIP X 3/8" FL	1	72
 <p>59DB04</p>	59 Oil Barrel Faucet - Locking Lever			
	59DB04	3/4" MIP x Plain Spout - Zamac	10	100
 <p>759SDS</p>	759SDS Ball Style Balancing Valve			
	<p> Lead Free Version Available</p> <p>600 WOG</p>			
	759C04SDS	3/4" C x C With Screwdriver Stop	10	60
 <p>PBVC04C</p>	PBVC Brass Purge & Balancing Valve			
	PBVC04C	3/4" SWT x 1/2" FIP With Drain Outlet	12	60
 <p>CIF04</p> <p>CIF05</p> <p>CIF06</p> <p>CIF04</p>	CIF Circulator Flange Kits - Cast Iron - With Bolts & Nuts			
	Complete with 2 Flanges, 4 Bolts, 4 Nuts			
	CIF04	3/4"	1	30
	CIF05	1"	1	30
CIF06	1-1/4"	1	30	

Notes

Carbon Steel Valves

Carbon Steel Valves



Stainless Steel Valves



Stainless Steel Valves

Valves

Carbon & Stainless Steel Valve Part # Breakdown

20SSFL08D

20 SS FL 08 D

Choose Series	
15	One Piece, Reduced Port
20	Two Piece, Full Port
25	Two Piece, Reduced Port
30	Three Piece, Full Port
40	Gate Valve
50	Globe Valve
60	Check Valve
70	Y Strainer

Choose Material	
CS	Carbon Steel
SS	Stainless Steel

Select Style	
D	Direct Mounting Pad
FL	Flange
M	Mounting Pad
SW	Socket Weld
TH	Threaded

Part #	Size
01	1/4"
02	3/8"
03	1/2"
04	3/4"
05	1"
06	1-1/4"
07	1-1/2"
08	2"
09	2-1/2"
10	3"
11	4"
13	6"
14	8"
15	10"



Carbon & Stainless Steel Ball Valves

Carbon & Stainless Steel Ball Valves



15SSTH

15SSTH

MATCO-NORCA MODEL NUMBER **SIZE** **WEIGHT**

Stainless Steel Threaded Ball Valve - One Piece - Reduced Port

**1000 WOG
Locking Handle**

MATCO-NORCA MODEL NUMBER	SIZE	WEIGHT
15SSTH01	1/4"	0.1
15SSTH02	3/8"	0.2
15SSTH03	1/2"	0.4
15SSTH04	3/4"	0.6
15SSTH05	1"	0.8
15SSTH06	1-1/4"	1.3
15SSTH07	1-1/2"	1.8
15SSTH08	2"	2.9

20SSFLD

Stainless Steel Flanged Ball Valve - Two Piece - Full Port

Class 150 API 607 Fire Safe Approved - Up to 6"
Locking & Anti-Static Device

ISO 5211 Direct Mount



20SSFLD

MATCO-NORCA MODEL NUMBER	SIZE	WEIGHT
20SSFL03D	1/2"	3.7
20SSFL04D	3/4"	4.6
20SSFL05D	1"	7.1
20SSFL06D	1-1/4"	8.2
20SSFL07D	1-1/2"	13.2
20SSFL08D	2"	17.6
20SSFL09D	2-1/2"	32.0
20SSFL10D	3"	40.2
20SSFL11D	4"	63.9
20SSFL13D	6"	114.6
20SSFL14D	8"	194.0
20SSFL15D	10"	315.3

20CSFLD

Carbon Steel Flanged Ball Valve - Two Piece - Full Port

Class 150 API 607 Fire Safe Approved - Up to 6"
Locking & Anti-Static Device

ISO 5211 Direct Mount



20CSFLD

MATCO-NORCA MODEL NUMBER	SIZE	WEIGHT
20CSFL03D	1/2"	3.7
20CSFL04D	3/4"	4.6
20CSFL05D	1"	7.1
20CSFL06D	1-1/4"	8.2
20CSFL07D	1-1/2"	13.2
20CSFL08D	2"	17.6
20CSFL09D	2-1/2"	32.0
20CSFL10D	3"	40.2
20CSFL11D	4"	63.9
20CSFL13D	6"	114.6
20CSFL15D	10"	315.3

Carbon & Stainless Steel Ball Valves



20SSTHM

20SSTHM

Stainless Steel Threaded Ball Valve - Two Piece - Full Port

**1000 WOG
Locking Handle
Mounting Pad**

MATCO-NORCA MODEL NUMBER	SIZE	WEIGHT
20SSTH01M	1/4"	0.5
20SSTH02M	3/8"	0.5
20SSTH03M	1/2"	0.7
20SSTH04M	3/4"	1.0
20SSTH05M	1"	1.7
20SSTH06M	1-1/4"	2.5
20SSTH07M	1-1/2"	3.9
20SSTH08M	2"	5.9
20SSTH09M	2-1/2"	12.4
20SSTH10M	3"	16.5

25SSTHM

Stainless Steel Threaded Ball Valve - Two Piece - Reduced Port

**1/4" - 1" 2000 WOG 1-1/4" - 2" 1500 WOG
Locking Handle
Mounting Pad**



25SSTHM

25SSTH01M	1/4"	0.7
25SSTH02M	3/8"	0.7
25SSTH03M	1/2"	0.7
25SSTH04M	3/4"	1.4
25SSTH05M	1"	1.8
25SSTH06M	1-1/4"	3.2
25SSTH07M	1-1/2"	4.1
25SSTH08M	2"	6.0

25CSTHM

Carbon Steel Threaded Ball Valve - Two Piece - Reduced Port

**1/4" - 1" 2000 WOG 1-1/4" - 2" 1500 WOG
Locking Handle
Mounting Pad**



25CSTHM

25CSTH01M	1/4"	0.7
25CSTH02M	3/8"	0.7
25CSTH03M	1/2"	0.7
25CSTH04M	3/4"	1.4
25CSTH05M	1"	1.8
25CSTH06M	1-1/4"	3.2
25CSTH07M	1-1/2"	4.1
25CSTH08M	2"	6.0

Stainless Steel Ball Valves

Stainless Steel
Ball Valves



30SSTH

MATCO-NORCA MODEL NUMBER	SIZE	WEIGHT
30SSTH Stainless Steel Threaded Ball Valve - Three Piece - Full Port		
1000 WOG Locking Handle		
30SSTH01	1/4"	0.8
30SSTH02	3/8"	0.8
30SSTH03	1/2"	1.1
30SSTH04	3/4"	1.5
30SSTH05	1"	2.2
30SSTH06	1-1/4"	3.5
30SSTH07	1-1/2"	5.5
30SSTH08	2"	7.7
30SSTH09	2-1/2"	14.8
30SSTH10	3"	20.9
30SSTH11	4"	42.1



30SSSW

MATCO-NORCA MODEL NUMBER	SIZE	WEIGHT
30SSSW Stainless Steel Socket Weld Ball Valve - Three Piece - Full Port		
1000 WOG Locking Handle		
30SSSW01	1/4"	0.8
30SSSW02	3/8"	0.8
30SSSW03	1/2"	1.1
30SSSW04	3/4"	1.5
30SSSW05	1"	2.2
30SSSW06	1-1/4"	3.5
30SSSW07	1-1/2"	5.5
30SSSW08	2"	7.7
30SSSW09	2-1/2"	14.8
30SSSW10	3"	20.9
30SSSW11	4"	42.1



30SSTHM

MATCO-NORCA MODEL NUMBER	SIZE	WEIGHT
30SSTHM Stainless Steel Threaded Ball Valve - Three Piece - Full Port		
1000 WOG Locking Handle ISO 5211 Mounting Pad		
30SSTH01M	1/4"	0.8
30SSTH02M	3/8"	0.8
30SSTH03M	1/2"	1.1
30SSTH04M	3/4"	1.5
30SSTH05M	1"	2.3
30SSTH06M	1-1/4"	3.6
30SSTH07M	1-1/2"	5.3
30SSTH08M	2"	7.7
30SSTH09M	2-1/2"	14.8
30SSTH10M	3"	21.6
30SSTH11M	4"	42.3



30SSWMM

MATCO-NORCA MODEL NUMBER	SIZE	WEIGHT
30SSWMM Stainless Steel Socket Weld Ball Valve - Three Piece - Full Port		
1000 WOG Locking Handle ISO 5211 Mounting Pad		
30SSW01M	1/4"	0.8
30SSW02M	3/8"	0.8
30SSW03M	1/2"	1.1
30SSW04M	3/4"	1.5
30SSW05M	1"	2.3
30SSW06M	1-1/4"	3.6
30SSW07M	1-1/2"	5.3
30SSW08M	2"	7.7
30SSW09M	2-1/2"	14.8
30SSW10M	3"	21.6
30SSW11M	4"	42.3

Carbon Steel Ball Valves



30CSTH

30CSTH

MATCO-NORCA MODEL NUMBER	SIZE	WEIGHT
Carbon Steel Threaded Ball Valve - Three Piece - Full Port		
1000 WOG Locking Handle		
30CSTH01	1/4"	0.8
30CSTH02	3/8"	0.8
30CSTH03	1/2"	1.1
30CSTH04	3/4"	1.5
30CSTH05	1"	2.2
30CSTH06	1-1/4"	3.5
30CSTH07	1-1/2"	5.5
30CSTH08	2"	7.7
30CSTH09	2-1/2"	14.8
30CSTH10	3"	20.9
30CSTH11	4"	42.1



30CSSW

30CSSW

MATCO-NORCA MODEL NUMBER	SIZE	WEIGHT
Carbon Steel Socket Weld Ball Valve - Three Piece - Full Port		
1000 WOG Locking Handle		
30CSSW01	1/4"	0.8
30CSSW02	3/8"	0.8
30CSSW03	1/2"	1.1
30CSSW04	3/4"	1.5
30CSSW05	1"	2.2
30CSSW06	1-1/4"	3.5
30CSSW07	1-1/2"	5.5
30CSSW08	2"	7.7
30CSSW09	2-1/2"	14.8
30CSSW10	3"	20.9
30CSSW11	4"	42.1



30CSTHM

30CSTHM

MATCO-NORCA MODEL NUMBER	SIZE	WEIGHT
Carbon Steel Threaded Ball Valve - Three Piece - Full Port		
1000 WOG Locking Handle ISO 5211 Mounting Pad		
30CSTH01M	1/4"	0.8
30CSTH02M	3/8"	0.8
30CSTH03M	1/2"	1.1
30CSTH04M	3/4"	1.5
30CSTH05M	1"	2.3
30CSTH06M	1-1/4"	3.6
30CSTH07M	1-1/2"	5.3
30CSTH08M	2"	7.7
30CSTH09M	2-1/2"	14.8
30CSTH10M	3"	21.6
30CSTH11M	4"	42.3



30CSSWM

30CSSWM

MATCO-NORCA MODEL NUMBER	SIZE	WEIGHT
Carbon Steel Socket Weld Ball Valve - Three Piece - Full Port		
1000 WOG Locking Handle ISO 5211 Mounting Pad		
30CSSW01M	1/4"	0.8
30CSSW02M	3/8"	0.8
30CSSW03M	1/2"	1.1
30CSSW04M	3/4"	1.5
30CSSW05M	1"	2.3
30CSSW06M	1-1/4"	3.6
30CSSW07M	1-1/2"	5.3
30CSSW08M	2"	7.7
30CSSW09M	2-1/2"	14.8
30CSSW10M	3"	21.6
30CSSW11M	4"	42.3

Stainless Steel Valves

Stainless Steel
Valves



40SSTH

40SSTH

Stainless Steel Threaded Gate Valve - NRS

200 WOG

MATCO-NORCA MODEL NUMBER	SIZE	WEIGHT
40SSTH03	1/2"	1.0
40SSTH04	3/4"	1.2
40SSTH05	1"	1.5
40SSTH06	1-1/4"	2.2
40SSTH07	1-1/2"	3.1
40SSTH08	2"	5.0

50SSTH

Stainless Steel Threaded Globe Valve - Rising Stem

200 WOG

50SSTH03	1/2"	0.7
50SSTH04	3/4"	1.0
50SSTH05	1"	1.5
50SSTH06	1-1/4"	2.2
50SSTH07	1-1/2"	2.8
50SSTH08	2"	4.0



50SSTH

60SSTH

Stainless Steel Threaded Check Valve

200 WOG

60SSTH03	1/2"	0.7
60SSTH04	3/4"	1.0
60SSTH05	1"	1.5
60SSTH06	1-1/4"	2.2
60SSTH07	1-1/2"	3.4
60SSTH08	2"	4.7



60SSTH

70SSTH

Stainless Steel Threaded Y Strainer - 40 Mesh Screen

800 WOG

70SSTH03	1/2"	0.5
70SSTH04	3/4"	0.8
70SSTH05	1"	1.5
70SSTH06	1-1/4"	1.9
70SSTH07	1-1/2"	3.0
70SSTH08	2"	5.2



70SSTH

Cast & Ductile Iron Valves

Cast Iron & Ductile Iron Valves Butterfly Valves & Accessories



Butterfly Valves & Accessories



Cast Iron & Ductile Iron Valves Butterfly Valves & Accessories

Valves

Cast Iron Gate Valves Resilient Wedge - Non-Rising Stem



200WW

200WW

Flanged Cast Iron Gate Valve - Resilient Wedge - NRS

AWWA C509 200 CWP

Fusion Bonded Epoxy

HANDWHEEL OP. NUT

MATCO-NORCA MODEL NUMBER	SIZE	WEIGHT
200W08W	200W08NW 2"	31
200W10W	200W10NW 3"	53
200W11W	200W11NW 4"	77
200W13W	200W13NW 6"	135
200W14W	200W14NW 8"	209
200W15W	200W15NW 10"	333
200W16W	200W16NW 12"	462
14" and 16" Sizes Of This Product Are Available As:		
100W17	14"	750
100W18	16"	1026



200MW

200MW

Mechanical Joint Cast Iron Gate Valve - Resilient Wedge - NRS

AWWA C509 200 CWP

Fusion Bonded Epoxy

OP. NUT OPEN RIGHT

MATCO-NORCA MODEL NUMBER	SIZE	WEIGHT
200M10W	- 3"	53
200M11W	200M11RW 4"	77
200M13W	200M13RW 6"	135
200M14W	200M14RW 8"	209
200M15W	200M15RW 10"	333
200M16W	200M16RW 12"	462
14" and 16" Sizes Of This Product Are Available As:		
100M17	14"	739
100M18	16"	942



200FJW

200FJW

Flanged X MJ Cast Iron Gate Valve - Resilient Wedge - NRS - For IPS Pipe

AWWA C509 200 CWP

Fusion Bonded Epoxy

OP. NUT

MATCO-NORCA MODEL NUMBER	SIZE	WEIGHT
200FJ10W	3"	53
200FJ11W	4"	77
200FJ13W	6"	135
200FJ14W	8"	209
200FJ15W	10"	333
200FJ16W	12"	462

Cast Iron Gate Valves Resilient Wedge - Non-Rising Stem



10RW

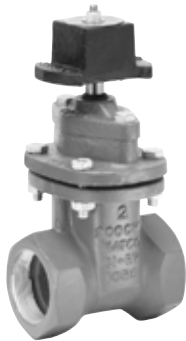

10RS-N



10RT

MATCO-NORCA MODEL NUMBER	SIZE	WEIGHT
10RW	Flanged Cast Iron Gate Valve - Resilient Wedge - NRS	
200 CWP 2" - 8" 150 CWP 10" - 12"		
3 Bosses - 1 Tapped & Plugged USC Approved		
Epoxy Coated		
HANDWHEEL	OP. NUT	
10RW08	10RW08N	2"
10RW09	-	2-1/2"
10RW10	10RW10N	3"
10RW11	10RW11N	4"
10RW12	10RW12N	5"
10RW13	10RW13N	6"
10RW14	10RW14N	8"
10RW15	-	10"
10RW16	-	12"
		25
		31
		42
		64
		97
		108
		191
		286
		393
10RS	Threaded Cast Iron Gate Valve - Resilient Wedge - NRS	
200 CWP		
Epoxy Coated		
HANDWHEEL	OP. NUT	
10RS08	10RS08N	2"
10RS09	10RS09N	2-1/2"
10RS10	10RS10N	3"
10RS11	10RS11N	4"
10RS12	-	5"
10RS13	-	6"
		18
		20
		26
		44
		77
		95
10RT	Ring-Tite Cast Iron Gate Valve - Resilient Wedge - NRS - For IPS Pipe	
200 CWP		
3 Bosses - 1 Tapped & Plugged		
Epoxy Coated		
OP. NUT		
10RT08		2"
10RT09		2-1/2"
10RT10		3"
10RT11		4"
10RT13		6"
10RT14		8"
		20
		22
		33
		46
		90
		154

Cast Iron Gate Valves

Ductile Iron Gate Valves Resilient Wedge - Non-Rising Stem

Ductile Iron Gate Valves



200WD

200WD

Flanged Ductile Iron Gate Valve - Resilient Wedge - NRS

AWWA C515 250 CWP

Fusion Bonded Epoxy

HANDWHEEL OP. NUT

MATCO-NORCA MODEL NUMBER	SIZE	WEIGHT
200WD08	2"	28
200WD09	2-1/2"	37
200WD10	3"	45
200WD11	4"	69
200WD13	6"	119
200WD14	8"	203
200WD15	10"	282
200WD16	12"	412
200WD18	16"	1,602

See 100W For 14" and 16" Sizes in Cast Iron On Page 40.



200MD

200MD

Mechanical Joint Ductile Iron Gate Valve - Resilient Wedge - NRS - Less Accessories

AWWA C515 250 CWP

Fusion Bonded Epoxy

OP. NUT

MATCO-NORCA MODEL NUMBER	SIZE	WEIGHT
200MD08	2"	28
200MD10	3"	44
200MD11	4"	56
200MD13	6"	98
200MD14	8"	160
200MD15	10"	245
200MD16	12"	311

See 100M For 14" and 16" Sizes in Cast Iron On Page 40.

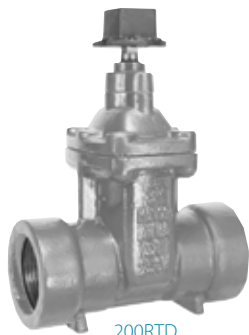

200RTD

200RTD

Ring-Tite Ductile Iron Gate Valve - Resilient Wedge - NRS - For IPS Pipe

AWWA C515 250 CWP

Fusion Bonded Epoxy

OP. NUT

MATCO-NORCA MODEL NUMBER	SIZE	WEIGHT
200RTD08	2"	25
200RTD09	2-1/2"	31
200RTD10	3"	38
200RTD11	4"	54
200RTD13	6"	104
200RTD14	8"	171
200RTD15	10"	289
200RTD16	12"	447



200TVD

200TVD

Ductile Iron Tapping Gate Valve - Resilient Wedge - NRS - Less Accessories

AWWA C515 250 CWP

Fusion Bonded Epoxy

OP. NUT

MATCO-NORCA MODEL NUMBER	SIZE	WEIGHT
200TVD10	3"	48
200TVD11	4"	63
200TVD13	6"	108
200TVD14	8"	173
200TVD15	10"	262
200TVD16	12"	374

Cast Iron Gate Valves IBBM - Iron Body Bronze Mounted

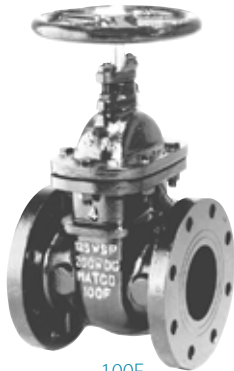

100F

MATCO-NORCA MODEL NUMBER	SIZE	WEIGHT
100F	Flanged Cast Iron Gate Valve - IBBM - NRS	
	125 SWP 200 WOG	
	3 Bosses MSS SP-70 WW-V-58-CL1	
	Bituminous Coated	
	HANDWHEEL	
100F08	2"	26
100F09	2-1/2"	35
100F10	3"	44
100F11	4"	77
100F12	5"	97
100F13	6"	128
100F14	8"	220
100F15	10"	315
100F16	12"	483
100F17	14"	807
100F18	16"	1077
100F19	18"	1301

OP. Nuts Available. See Page 53 for Part Numbers.



105F

MATCO-NORCA MODEL NUMBER	SIZE	WEIGHT
105F	Flanged Cast Iron Gate Valve - OS&Y - IBBM - Rising Stem	
	125 SWP 200 WOG	
	3 Bosses MSS SP-70 WW-V-58-CL1	
	Bituminous Coated	
105F08	2"	29
105F09	2-1/2"	37
105F10	3"	50
105F11	4"	86
105F12	5"	115
105F13	6"	150
105F14	8"	249
105F15	10"	374
105F16	12"	524
105F17	14"	816
105F18	16"	1187
105F19	18"	1413
105F20	20"	2104
105F24	24"	3184



100S

MATCO-NORCA MODEL NUMBER	SIZE	WEIGHT
100S	Threaded Cast Iron Gate Valve - IBBM - NRS	
	125 SWP 200 WOG	
	MSS SP-70 WW-V-58-CL1	
	Bituminous Coated	
	HANDWHEEL	
100S08	2"	23
100S09	2-1/2"	25
100S10	3"	34
100S11	4"	58
100S12	5"	77
100S13	6"	111

Cast Iron Gate Valves

IBBM - Iron Body Bronze Mounted



105S

105S

**MATCO-NORCA
MODEL NUMBER**

SIZE

WEIGHT

Threaded Cast Iron Gate Valve - OS&Y - IBBM - Rising Stem

**125 SWP 200 WOG
MSS SP-70 WW-V-58-CL1
Bituminous Coated**

105S08	2"	25
105S09	2-1/2"	27
105S10	3"	40
105S11	4"	66
105S13	6"	135

200F

Flanged Cast Iron Gate Valve - IBBM - NRS

**200 WOG - Not for Steam Service
MSS SP-70**

**Bituminous Coated
HANDWHEEL**



200F

200F09	2-1/2"	39
200F10	3"	47
200F11	4"	66
200F13	6"	139
200F14	8"	201
200F15	10"	295

OP. Nuts Available. See Page 53 for Part Numbers.

205F

Flanged Cast Iron Gate Valve - OS&Y - IBBM - Rising Stem

**200 WOG - Not for Steam Service
MSS SP-70**

Bituminous Coated



205F

205F10	3"	51
205F11	4"	75
205F13	6"	141
205F14	8"	223
205F15	10"	322

Cast Iron & Ductile Iron Gate Valves

Cast Iron Globe Valve



105W

105W

**MATCO-NORCA
MODEL NUMBER**

SIZE

WEIGHT

Flanged Cast Iron Gate Valve - OS&Y - Resilient Wedge - Rising Stem

AWWA C509 3" - 12" 200 CWP 14" - 16" 150 CWP

3 Bosses - 1 Tapped & Plugged

Fusion Bonded Epoxy

105W10	3"	64
105W11	4"	93
105W13	6"	157
105W14	8"	269
105W15	10"	436
105W16	12"	597
105W17	14"	827
105W18	16"	1135

USC
University
of Southern
California



105U

Flanged Cast Iron Gate Valve - OS&Y - Resilient Wedge - Rising Stem

175 CWP

3 Bosses - 1 Tapped & Plugged N.Y.C. APPROVED USC Approved

Fusion Bonded Epoxy

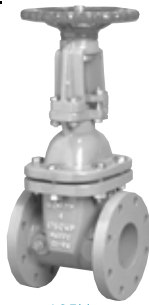

105U

105U09	2-1/2"	50
105U10	3"	66
105U11	4"	97
105U13	6"	164
105U14	8"	283
105U15	10"	456
105U16	12"	754



205U

Flanged Ductile Iron Gate Valve - OS&Y - Resilient Wedge - Rising Stem

AWWA C515 300 CWP Max. Temperature 160° F

4 Bosses - 1 Tapped & Plugged

Fusion Bonded Epoxy Coating - AWWA C550



205U

205U09	2-1/2"	58
205U10	3"	69
205U11	4"	104
205U13	6"	172
205U14	8"	243
205U15	10"	441
205U16	12"	684

150F

Flanged Cast Iron Globe Valve - OS&Y - IBBM - Rising Stem

125 SWP 200 CWP

MSS-SP-85

Bituminous Coated



150F

150F08	2"	38
150F09	2-1/2"	49
150F10	3"	60
150F11	4"	99
150F13	6"	187
150F14	8"	315

Valves

Cast Iron Swing Check Valves IBBM & Resilient Seat



115F

MATCO-NORCA MODEL NUMBER	SIZE	WEIGHT
115F	Flanged Cast Iron Swing Check Valve - IBBM	
125 SWP 200 WOG		
One Boss MSS-SP-71 Bituminous Coated		
115F08	2"	20
115F09	2-1/2"	31
115F10	3"	42
115F11	4"	69
115F12	5"	80
115F13	6"	115
115F14	8"	231
115F15	10"	357
115F16	12"	498



115S

MATCO-NORCA MODEL NUMBER	SIZE	WEIGHT
115S	Threaded Cast Iron Swing Check Valve - IBBM	
125 SWP 200 WOG		
MSS-SP-71 Bituminous Coated		
115S08	2"	14
115S09	2-1/2"	18
115S10	3"	27
115S11	4"	53
115S12	5"	79



120F

MATCO-NORCA MODEL NUMBER	SIZE	WEIGHT
120F	Flanged Cast Iron Swing Check Valve - Resilient Seat	
200 CWP		
One Boss MSS-SP-71 Epoxy Coated		
120F08	2"	20
120F09	2-1/2"	31
120F10	3"	41
120F11	4"	69
120F12	5"	79
120F13	6"	115
120F14	8"	230
120F15	10"	356
120F16	12"	497



120S

MATCO-NORCA MODEL NUMBER	SIZE	WEIGHT
120S	Threaded Cast Iron Swing Check Valve - Resilient Seat	
200 CWP		
MSS-SP-71 Epoxy Coated		
120S08	2"	14
120S09	2-1/2"	18
120S10	3"	27
120S11	4"	53
120S13	6"	99

Cast Iron Swing Check Valves Resilient Seat

Cast Iron Check Valves



120W

120W

**MATCO-NORCA
MODEL NUMBER**

SIZE

WEIGHT

Flanged Cast Iron Swing Check Valve - Resilient Seat

AWWA C508 200 CWP

One Boss Fusion Bonded Epoxy

120W10	3"	56
120W11	4"	75
120W13	6"	144
120W14	8"	275
120W15	10"	435
120W16	12"	594

120WC

Flanged Cast Iron Check Valve - Resilient Seat - Outside Lever And Weight

AWWA C508 3" - 12" - 200 CWP 14" - 16" - 150 CWP

One Boss Fusion Bonded Epoxy



120WC



P120WSK

120WC10	3"	57
120WC11	4"	84
120WC13	6"	156
120WC14	8"	294
120WC15	10"	466
120WC16	12"	627
120WC17	14"	873
120WC18	16"	1025

P120WSK Spring Kit Available For 120WC.

P120WLW Replacement Lever & Weight Available for 120WC.



120U

Flanged Cast Iron Swing Check Valve - Resilient Seat

175 CWP

**One Boss N.Y.C. Approved
Fusion Bonded Epoxy**



120U

MODEL NUMBER	SIZE	DRAIN ON BOTTOM	WEIGHT
120U09	2-1/2"	1/2"	44
120U10	3"	1/2"	51
120U11	4"	1/2"	79
120U13	6"	3/4"	152
120U14	8"	1"	312
120U15	10"	1"	462
120U16	12"	1"	662

Wafer Style Check Valves

Cast Iron Check Valves



CVC

MATCO-NORCA MODEL NUMBER	SIZE	WEIGHT
CVC	Wafer Check Valve - Double Bronze Disc - BUNA-N Seat	
	Class 125 200 WOG	
	Cast Iron Body - SS Springs & Shaft	
CVC - 2	2"	4
CVC - 2.5	2-1/2"	5
CVC - 3	3"	8
CVC - 4	4"	13
CVC - 5	5"	16
CVC - 6	6"	20
CVC - 8	8"	38
CVC - 10	10"	57
CVC - 12	12"	92
CVC - 14	14"	121
CVC - 16	16"	165



SC

MATCO-NORCA MODEL NUMBER	SIZE	WEIGHT
SC	Silent Wafer Check Valve - Poppet Style - Bronze Disc And Seat	
	Class 125 200 WOG	
	Cast Iron Body - SS Spring	
SC-2	2"	7
SC-2.5	2-1/2"	9
SC-3	3"	15
SC-4	4"	25
SC-5	5"	32
SC-6	6"	56
SC-8	8"	100
SC-10	10"	140
SC-12	12"	340

Cast Iron Y Strainers



140F

**MATCO-NORCA
MODEL NUMBER**

SIZE

WEIGHT

140F

Flanged Cast Iron Y Strainer

**125 SWP 200 WOG
Bituminous Coated**

140F08	2"	20
140F09	2-1/2"	31
140F10	3"	42
140F11	4"	73
140F12	5"	107
140F13	6"	121
140F14	8"	198
140F15	10"	372
140F16	12"	539

140S

Threaded Cast Iron Y Strainer

**250 SWP
Bituminous Coated**



140S

140S01	1/4"	1
140S02	3/8"	1
140S03	1/2"	1
140S04	3/4"	2
140S05	1"	3
140S06	1-1/4"	5
140S07	1-1/2"	7
140S08	2"	12
140S09	2-1/2"	27
140S10	3"	38

Cast Iron Flanges: Companion, Reducing, Blind, PVC Van Stone Flanges

**MATCO-NORCA
MODEL NUMBER**

CICF

Cast Iron Companion Flange



CICFB



CICFG

Black	Galv.	Flange x O.D.	# Of Holes	Weight
CICFB07	CICFG07	1-1/2" x 5"	4	3
CICFB08	CICFG08	2" x 6"	4	4
CICFB09	CICFG09	2-1/2" x 7"	4	6
CICFB10	CICFG10	3" x 7-1/2"	4	8
CICFB11	CICFG11	4" x 9"	8	12
CICFB12	CICFG12	5" x 10"	8	14
CICFB13	CICFG13	6" x 11"	8	17
CICFB14	CICFG14	8" x 13-1/2"	8	26
CICFB15	CICFG15	10" x 16"	12	38
CICFB16	CICFG16	12" x 19"	12	57

**MATCO-NORCA
MODEL NUMBER**

CIRF

Cast Iron Reducing Flange



CIRFB



CIRFG

Black	Galv.	Flange x IPS	IPS x O.D.	# Of Holes	Weight
CIRFB32	CIRFG32	3" x 2"	2" x 7-1/2"	4	9
CIRFB42	CIRFG42	4" x 2"	2" x 9"	8	14
CIRFB43	CIRFG43	4" x 3"	3" x 9"	8	13
CIRFB54	CIRFG54	5" x 4"	4" x 10"	8	16
CIRFB62	CIRFG62	6" x 2"	2" x 11"	8	26
CIRFB63	CIRFG63	6" x 3"	3" x 11"	8	23
CIRFB64	CIRFG64	6" x 4"	4" x 11"	8	21
CIRFB65	CIRFG65	6" x 5"	5" x 11"	8	19
CIRFB82	CIRFG82	8" x 2"	2" x 13-1/2"	8	44
CIRFB83	CIRFG83	8" x 3"	3" x 13-1/2"	8	40
CIRFB84	CIRFG84	8" x 4"	4" x 13-1/2"	8	37
CIRFB85	CIRFG85	8" x 5"	5" x 13-1/2"	8	34
CIRFB86	CIRFG86	8" x 6"	6" x 13-1/2"	8	31

CIBF

Cast Iron Blind Flange



CIBF

Black	Nominal Size	Flange x O.D.	# Of Holes	Weight
CIBFB08	2"	2" x 6"	4	5
CIBFB09	2-1/2"	2-1/2" x 7"	4	7
CIBFB10	3"	3" x 7-1/2"	4	9
CIBFB11	4"	4" x 9"	8	16
CIBFB13	6"	6" x 11"	8	25
CIBFB14	8"	8" x 13-1/2"	8	42
CIBFB15	10"	10" x 16"	12	65
CIBFB16	12"	12" x 19"	12	85

PVCF

**PVC Van Stone Flange - (Sch 80)
Socket (Swivel)**



PVCF

		# Of Holes	Weight
PVCF08	2"	4	1
PVCF10	3"	4	2
PVCF11	4"	8	3
PVCF12	5"	8	4
PVCF13	6"	8	4
PVCF14	8"	8	6
PVCF15	10"	12	11
PVCF16	12"	12	20

Accessories: Gaskets, Bolts & Bolt & Gasket Sets

Accessories

**MATCO-NORCA
MODEL NUMBER**

SIZE

GSNA/GNA 150# Non-Asbestos Ring Bolt Pack - 1/16"

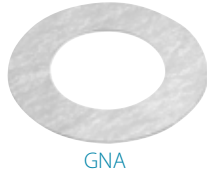

GSNA

GNA

Gasket Only

GSNAG2	GNA2	2"
GSNAG2.5	GNA2.5	2-1/2"
GSNAG3	GNA3	3"
GSNAG4	GNA4	4"
GSNAG5	GNA5	5"
GSNAG6	GNA6	6"
GSNAG8	GNA8	8"
GSNAG10	GNA10	10"
GSNAG12	GNA12	12"
GSNAG14	GNA14	14"
GSNAG16	GNA16	16"

**MATCO-NORCA
MODEL NUMBER**

SIZE

GSNAFF/GFFNA 150# Non-Asbestos Full Face Bolt Pack - 1/16"

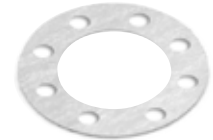
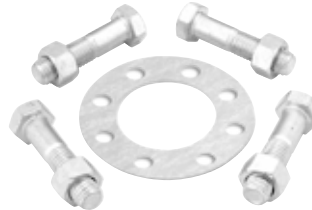

GFFNA

GSNAFFG

Gasket Only

GSNAFFG2	GFFNA2	2"
GSNAFFG2.5	GFFNA2.5	2-1/2"
GSNAFFG3	GFFNA3	3"
GSNAFFG4	GFFNA4	4"
GSNAFFG5	GFFNA5	5"
GSNAFFG6	GFFNA6	6"
GSNAFFG8	GFFNA8	8"

GSFF/GFF 150# Full Face Red Rubber Bolt Pack - 1/8"

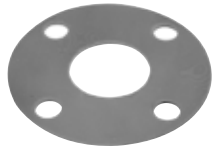
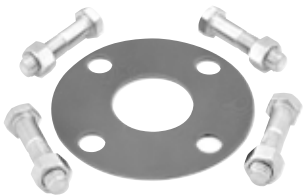

GSFF

GFF

Gasket Only

GSFFG2	GFF2	2"
GSFFG2.5	GFF2.5	2-1/2"
GSFFG3	GFF3	3"
GSFFG4	GFF4	4"
GSFFG5	GFF5	5"
GSFFG6	GFF6	6"
GSFFG8	GFF8	8"
GSFFG10	GFF10	10"
GSFFG12	GFF12	12"
GSFFG14	GFF14	14"
GSFFG16	GFF16	16"

GSNAX/GNAX 300# Non-Asbestos Ring Bolt Pack - 1/16"



GSNA

GNA

Gasket Only

GSNAXG2	GNAX2	2"
GSNAXG2.5	GNAX2.5	2-1/2"
GSNAXG3	GNAX3	3"
GSNAXG4	GNAX4	4"
GSNAXG5	GNAX5	5"
GSNAXG6	GNAX6	6"
GSNAXG8	GNAX8	8"

SBG Plated Stud Bolt, Nut And Washer Set

For Wafer Butterfly Valves

	Fits Sizes	Quantity and Bolt Size
SBG2	2" & 2-1/2"	(4) 5/8" x 6"
SBG3	3"	(4) 5/8" x 7"
SBG4	4"	(8) 5/8" x 7"
SBG6	5", 6" & 8"	(8) 3/4" x 7"
SBG10	10" & 12"	(12) 7/8" x 8"
SBG14	14"	(12) 1" x 8"
SBG16	16"	(16) 1" x 10"



SBG

Mechanical Joint Accessory Kits

T-Wrench For Cast & Ductile Valves



100MJ

MATCO-NORCA MODEL NUMBER	SIZE	WEIGHT
100MJ	MJ Accessory Kit - Fits Ductile Iron & C-900 Pipe Includes - STD T-Head Bolts, MJ Gasket & D.I. Gland	
100MJ2	2"	5
100MJ3	3"	7
100MJ4	4"	8
100MJ6	6"	12
100MJ8	8"	15
100MJ10	10"	20
100MJ12	12"	25
100MJ14	14"	25
100MJ16	16"	25



100MJX

MATCO-NORCA MODEL NUMBER	SIZE	WEIGHT
100MJX	MJ Transition Accessory Kit - Fits (IPS) PVC & Steel Pipe Includes - STD T-Head Bolts, Transition Gasket & D.I. Gland	
100MJX2	2"	5
100MJX3	3"	7
100MJX4	4"	8
100MJX6	6"	12
100MJX8	8"	15
100MJX10	10"	20
100MJX12	12"	25



EMKL

MATCO-NORCA MODEL NUMBER	SIZE	WEIGHT
EMKL	T-Wrench For 2" Operating Nut	
EMKL36	36"	
EMKL60	60"	

Wheel Handles & Operating Nuts For Iron Gate Valves

WH Wheel Handles For Iron Gate Valves



P-2WH



P-WH-U

MATCO-NORCA MODEL #	SIZE	FITS MODEL #	SIZE	FITS MODEL #
P-WH-A	2", 2-1/2"	10RS/W/T		
P-WH-B	3"	10RS/W/T	2", 2-1/2"	100F/S
P-WH-C	4"	10RS/W/T	3"	100F/S
P-WH-D	4"	100F/S		
P-WH-E	5", 6"	10RS/W/T	5", 6"	100F/S
P-WH-F	8"	10RS/W/T	8"	100F/S
P-WH-G	10"	10RS/W/T	10"	100F
P-WH-H	12"	10RS/W/T	12"	100F
P-WH-U3	2-1/2, 3"	105U		
P-WH-U4	4"	105U		
P-WH-U6	6"	105U		
P-WH-U8	8"	105U		
P-WH-U10	10"	105U		
P-WH-U12	12"	105U		
P105FA	2"	105F/S	2", 2-1/2"	12RW
P105FB	2-1/2"	105F/S	3"	12RW
P105FC	3"	105F/S/W	4"	12RW
P105FD	4"	105F/S/W	5", 6"	12RW
P105FE	5"	105F/S		
P105FG	6"	105F/S/W		
P105FH	8"	105F/S/W		
P105FI	10"	105F/S/W		
P105FJ	12"	105F/S/W		
P-2DWH8	2"	200WD/WW/MW	2"	100RTW
P-2DWH9	2-1/2"	200WD/WW/MW	2-1/2"	100RTW
P-2DWH10	3"	200WD/WW/MW/FJW	3"	100RTW
P-2DWH11	4"	200WD/WW/MW/FJW	4"	100RTW
P-2DWH13	6"	200WD/WW/MW/FJW	6"	100RTW
P-2DWH14	8"	200WD/WW/MW/FJW	8"	100RTW
P-2DWH15	10"	200WD/WW/MW/FJW	10"	100RTW
P-2DWH16	12"	200WD/WW/MW/FJW	12"	100RTW
Old Style Handwheels				
P-2WH10	3"	200W/M/FJ	3"	100RT
P-2WH11	4"	200W/M/FJ	4"	100RT
P-2WH13	6"	200W/M/FJ	6"	100RT
P-2WH14	8"	200W/M/FJ	8"	100RT
P-2WH15	10"	200W/M/FJ	10"	100RT

OP 2" Operating Nut For NRS Iron Gate Valves



P-100NB



P-100NL

MATCO-NORCA MODEL #	SIZE	FITS MODEL #	SIZE	FITS MODEL #
P-100NA	2", 2-1/2"	10RS/W/T		
P-100NB	3"	10RS/W/T	2", 2-1/2"	100F/S
P-100NC	4"	10RS/W/T	3"	100F/S
		200F		
P-100ND	4"	100F/S		
		200F		
P-100NE	5", 6"	10RS/W/T	5", 6"	100F/S
		200F		
P-100NF	8"	10RS/W/T	8"	100F/S
		200F		
P-100NG	10"	10RW	10"	100F
P-100NH	12"	10RW	12"	100F
P-100NL	14"	100W/M/F		
P-100NM	16"	100F		
P-100NO	18"	100F		
P-100NP	16"	100W/M		
P-200NK	10" - 12"	200W/M		

OP 2" Operating Nut For NRS Iron Gate Valves



P-200DNC

P-200DNC	2" - 4"
P-200DND	6" - 8"
P-200DNF	10"
P-200DNG	12"

Butterfly Valve Part # Breakdown

B5-RLO4

B5 **RLO** **4** **-**

Choose Series
B1
B5
B6
B7

Select Style	
RLO	Wafer Style, Lever Operated
RWG	Wafer Style, Gear Operated
LGL	Lug Style, Lever Operated
LGG	Lug Style, Gear Operated

Part#	Size
2	2"
2.5	2-1/2"
3	3"
4	4"
5	5"
6	6"
8	8"
10	10"
12	12"
Through 36"	

Disc & Liner	Example
-	Nickel Plated Ductile Iron Disc - BUNA-N Liner B5-RLO4
AB	Aluminum-Bronze Disc - BUNA-N Liner B5-RLO4AB
ABE	Aluminum-Bronze Disc - EPDM Liner B5-RLO4ABE
S	316 Stainless Steel Disc - BUNA-N Liner B5-RLO4S
SE	316 Stainless Steel Disc - EPDM Liner B5-RLO4SE

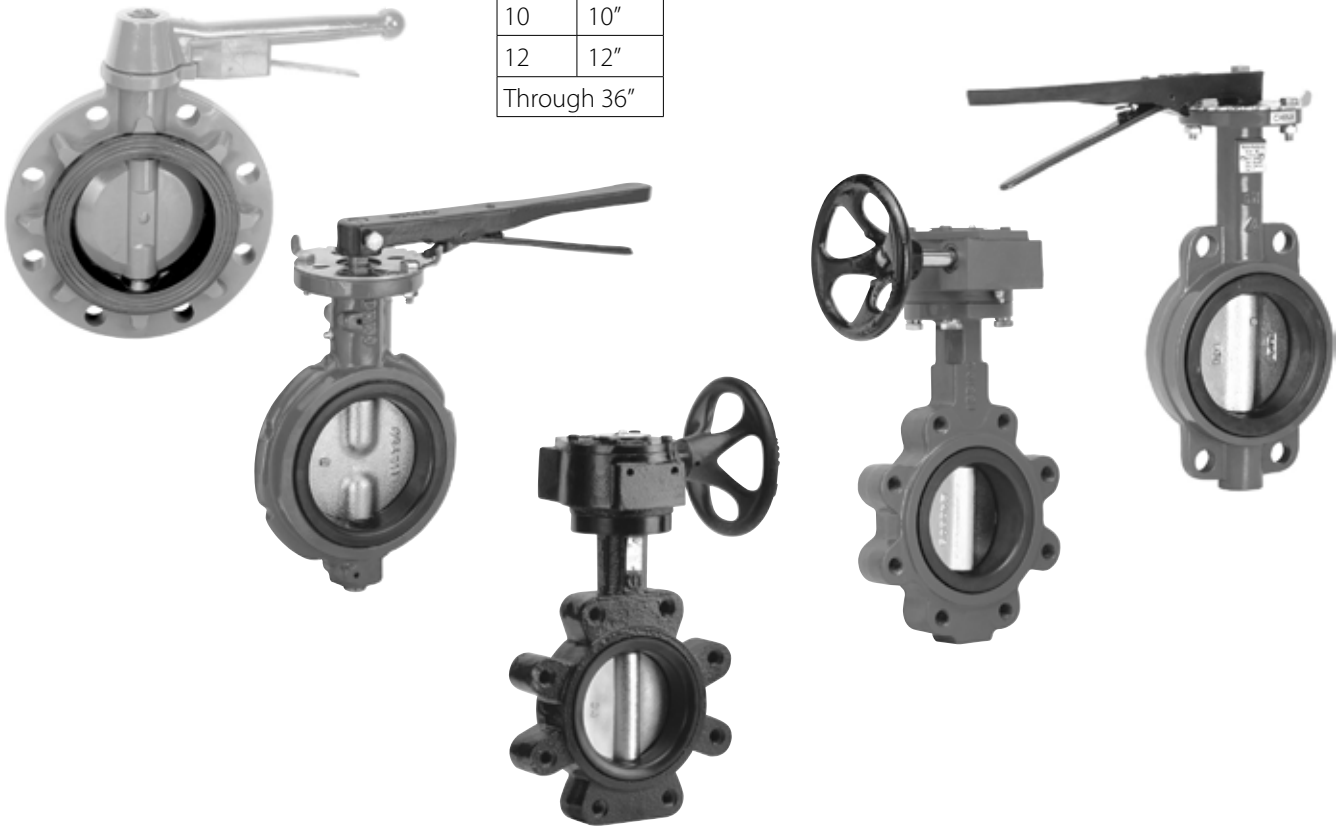

Butterfly Valve Part # Breakdown

B1 PVC Butterfly Valves & Parts

MATCO-NORCA MODEL NUMBER		SIZE	WEIGHT
B1	PVC Wafer Butterfly Valve - 200 PSI		

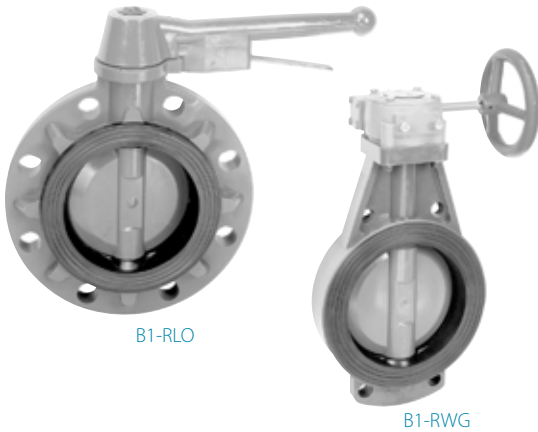

B1-RLO 10 Position Lock Lever Operated

B1-RLO2	2"	4
B1-RLO2.5	2-1/2"	4
B1-RLO3	3"	7
B1-RLO4	4"	8
B1-RLO6	6"	11

B1-RWG Gear Operated

B1-RWG8	8"	28
B1-RWG10	10"	36
B1-RWG12	12"	65

Valves Only Available with Stainless Steel Stem, EPDM Liner, Polypropylene Disc.

B1 Parts

MATCO-NORCA MODEL NUMBER		SIZE	WEIGHT
B1L	Lever Handle For B1 Butterfly Valve		

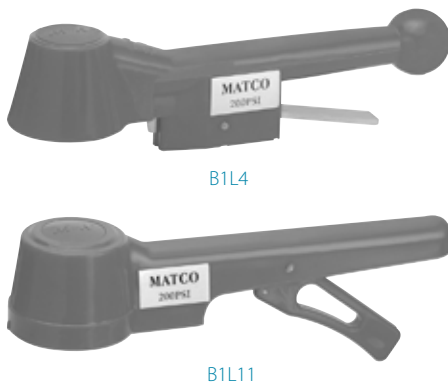

Replacement Handles For B1 Butterfly Valve

Round End - Old Style

B1L3	3"
B1L4	4"
B1L6	6"

Square End - New Style

B1L10	3"
B1L11	4"
B1L13	6"

B1 Butterfly Valves & Parts

B5 Butterfly Valves

Gear or 10 Position Lock Lever Operated

MATCO-NORCA
MODEL NUMBER SIZE WEIGHT

B5-RLO **Cast Iron Wafer Butterfly Valve - 200 PSI**



B5-RLO2	2"	9
B5-RLO2.5	2-1/2"	11
B5-RLO3	3"	12
B5-RLO4	4"	15
B5-RLO5	5"	19
B5-RLO6	6"	22
B5-RLO8	8"	39
B5-RLO10	10"	55
B5-RLO12	12"	75

MATCO-NORCA
MODEL NUMBER SIZE WEIGHT

B5-LGL **Cast Iron Lug Butterfly Valve - 200 PSI**



B5-LGL2	2"	10
B5-LGL2.5	2-1/2"	12
B5-LGL3	3"	13
B5-LGL4	4"	20
B5-LGL5	5"	24
B5-LGL6	6"	26
B5-LGL8	8"	45
B5-LGL10	10"	64
B5-LGL12	12"	86

B5-RWG **Cast Iron Wafer Butterfly Valve**



2" - 12" Valves Are Rated 200 PSI
14" - 36" Valves Are Rated 150 PSI

B5-RWG2	2"	18
B5-RWG2.5	2-1/2"	20
B5-RWG3	3"	21
B5-RWG4	4"	24
B5-RWG5	5"	29
B5-RWG6	6"	31
B5-RWG8	8"	59
B5-RWG10	10"	75
B5-RWG12	12"	102
B5-RWG14	14"	125
B5-RWG16	16"	207
B5-RWG18	18"	251
B5-RWG20	20"	349
B5-RWG24	24"	448
B5-RWG30	30"	1155
B5-RWG36	36"	1859

B5-LGG **Cast Iron Lug Butterfly Valve**



2" - 12" Valves Are Rated 200 PSI
14" - 36" Valves Are Rated 150 PSI

B5-LGG2	2"	21
B5-LGG2.5	2-1/2"	21
B5-LGG3	3"	24
B5-LGG4	4"	29
B5-LGG5	5"	33
B5-LGG6	6"	35
B5-LGG8	8"	64
B5-LGG10	10"	83
B5-LGG12	12"	113
B5-LGG14	14"	149
B5-LGG16	16"	244
B5-LGG18	18"	282
B5-LGG20	20"	374
B5-LGG24	24"	662
B5-LGG30	30"	1250
B5-LGG36	36"	2050

*Available with Nickel Plated Ductile Disc;
Available with BUNA-N Liner; See Butterfly Valve Part # Breakdown Page 54.*

B5 Butterfly Valve Parts & Accessories

MATCO-NORCA MODEL NUMBER **SIZE**

B5L **Lever Handle For B5 Butterfly Valve**



B5L3	2" - 3"
B5L4	4"
B5L6	6"
B5L8	8"
B5L10	10"
B5L12	12"

B5IND **Index Plate For B5 Butterfly Valve**



Chrome Plated

B5IND23	2" - 3"
B5IND810	8 - 10"
B5IND12	12"

Stainless Steel Plated

B5IND3S	3"
B5IND4S	4"
B5IND6S	6"

B5GRNUT **Gear Nut For B5 Butterfly Valve**



B5GRNUT6	2" - 6"
B5GRNUT12	8" - 12"
B5GRNUT14	14"
B5GRNUT16	16"
B5GRNUT18	18"
B5GRNUT20	20"
B5GRNUT24	24"

MATCO-NORCA MODEL NUMBER **SIZE** **MATCO-NORCA MODEL NUMBER** **SIZE**

B5G **Gear For B5 Butterfly Valve**



With Handwheel & Pin

B5G23	2" - 3"	B5G14	14"
B5G4	4"	B5G16	16"
B5G56	5" - 6"	B5G18	18"
B5G8	8"	B5G24	24"
B5G10	10"		
B5G12	12"		
B5G12R	12" Rounded		

B5WH **Hand Wheel For B5 Butterfly Valve**



B5-WH2	2" - 6"
B5-WH8	8" - 12"
B5-WH16	16"
B5-WH18	18"
B5-WH30	30"
B5-WH36	36"

B5X **Stem Extension For B5 Butterfly Valve**



	Fits Valve Size	Length of Extension
B5-X** A	2" - 3"	24"
B5-X** B	4"	36"
B5-X** C	5" - 6"	48"
B5-X** D	8"	60"
B5-X** E	10"	72"
B5-X** F	12"	
B5-X** G	14"	
B5-X** H	16"	
B5-X** I	18"	
B5-X** J	20"	
B5-X** K	24"	

Example: B5-X24-A=

24" Extension For
2" - 3" Butterfly Valve

****Place Holder For Length of Extension.
Flat & Round Extensions Also Available.**

B5LCH **Latch Nut For B5 Butterfly Valve**



B5-LCH-3	2" - 3"
B5-LCH-4	4"
B5-LCH-6	6"

B6 Butterfly Valves

Gear or 10 Position Lock Lever Operated

**MATCO-NORCA
MODEL NUMBER**

SIZE

WEIGHT

B6-RLO

Cast Iron Wafer Butterfly Valve - 200 PSI



B6-RLO

B6-RLO2	2"	7
B6-RLO2.5	2-1/2"	9
B6-RLO3	3"	10
B6-RLO4	4"	13
B6-RLO5	5"	17
B6-RLO6	6"	19
B6-RLO8	8"	31
B6-RLO10	10"	45
B6-RLO12	12"	74

**MATCO-NORCA
MODEL NUMBER**

SIZE

WEIGHT

B6-LGL

Cast Iron Lug Butterfly Valve - 200 PSI



B6-LGL

B6-LGL2	2"	10
B6-LGL2.5	2-1/2"	11
B6-LGL3	3"	13
B6-LGL4	4"	22
B6-LGL5	5"	26
B6-LGL6	6"	33
B6-LGL8	8"	42
B6-LGL10	10"	63
B6-LGL12	12"	92

**B6 Butterfly
Valves**

B6-RWG

Cast Iron Wafer Butterfly Valve - 200 PSI



B6-RWG

B6-RWG2	2"	17
B6-RWG2.5	2-1/2"	18
B6-RWG3	3"	19
B6-RWG4	4"	22
B6-RWG5	5"	27
B6-RWG6	6"	29
B6-RWG8	8"	55
B6-RWG10	10"	68
B6-RWG12	12"	101

B6-LGG

Cast Iron Lug Butterfly Valve - 200 PSI



B6-LGG

B6-LGG2	2"	20
B6-LGG2.5	2-1/2"	21
B6-LGG3	3"	22
B6-LGG4	4"	31
B6-LGG5	5"	36
B6-LGG6	6"	43
B6-LGG8	8"	63
B6-LGG10	10"	86
B6-LGG12	12"	118

Valves Only Come With Stainless Steel Stem, BUNA-N Seat, Ductile Disc.

B6 Butterfly Valve Parts

B7 Butterfly Valve

**MATCO-NORCA
MODEL NUMBER**

SIZE

B6L

Lever Handle For B6 Butterfly Valve



B6L3	2" - 3"
B6L4	4"
B6L6	6"
B6L8	8"
B6L10	10"
B6L12	12"

**MATCO-NORCA
MODEL NUMBER**

SIZE

B6G

Gear For B6 Butterfly Valve



With Handwheel & Pin

B6G23	2" - 3"
B6G4	4"
B6G56	5 - 6"
B6G8	8"
B6G10	10"
B6G12	12"

B6IND

Index Plate For B6 Butterfly Valve



B6IND26	2" - 6"
B6IND812	8" - 12"

B7 Butterfly Valve

**MATCO-NORCA
MODEL NUMBER**

SIZE

WEIGHT

B7

Cast Iron Wafer Butterfly Valve - Double Stem - 200 PSI - Short Neck



B7-RLO

B7-RLO2	2"	8
B7-RLO2.5	2-1/2"	10
B7-RLO3	3"	11
B7-RLO4	4"	15
B7-RLO5	5"	20
B7-RLO6	6"	22
B7-RLO8	8"	36
B7-RLO10	10"	51
B7-RLO12	12"	71

Available With Stainless Steel Stem, BUNA-N Liner, Ductile Disc or Aluminum Bronze Disc.

Terms & Conditions Of Sale

Acceptance

Orders, whether verbal or written, are subject to acceptance by Matco-Norca, Inc. Hereinafter referred to as the seller at its Brewster, N.Y. office. No terms or conditions of buyers order contrary to seller's terms and conditions shall be binding upon seller unless specifically agreed upon by seller in writing. Sellers acceptance of orders shall occur by written acknowledgement or tender of delivery of goods and or services the subject hereof (goods), which ever occurs first.

Prices And Sales Policy

Until written confirmation of this contract has been received by buyer, all prices are subject to change without prior notice. We reserve the right to adjust orders to standard package quantities unless otherwise stated on buyers purchase order. We reserve the right to make product improvement without notice. If seller determines buyer's credit is unsatisfactory or there is reasonable doubt concerning buyer's ability to pay, payment in advance may be required or buyer shall provide security for such payment in an amount and form acceptable to seller. Unless otherwise specified by seller, terms are 2% 10 days/net 30 days.

Cash discounts apply to the value of goods at the net invoiced value before transportation charges, taxes and additional duties. Unearned cash discounts will be charged back as an unpaid balance to the buyers account. Any past due amount is subject to a finance charge of 1-1/2% per month (18% per year) on the total past due balance in accordance with the Truth-in-lending Act in Title 1 of the Federal Consumer Protection Act effective July 1, 1969.

Taxes

All prices are exclusive of taxes and excises. Sales, use and other taxes, by whomsoever levied, are to be paid by the buyer and unless invoiced, are to be paid by buyer direct to the appropriate governmental agency. Buyers are required to furnish seller with a copy of their tax exemption of resale certificate, otherwise applicable state sales taxes will be charged.

Delivery And Shipment Of Materials

All goods are sold F.O.B. sellers warehouse. Delivery of material to a common carrier shall constitute delivery thereof to buyer and risk of loss shall pass to buyer at such time. Claims for damage to or loss of material in transit shall be filed by buyer direct with carrier. Buyer assumes all risks and liability for the results obtained by the use of material delivered hereunder. No claim of any kind, whether as to material delivered or for nondelivery or late delivery of material and whether based on negligence or otherwise, shall be greater in amount than the purchase price of the material in respect to which such claim is made. In no event shall seller be liable for indirect or consequential damages or for anticipated profits or loss of use of equipment.

Returns And Cancellations

Permission in writing and return authorization must be obtained from seller before any goods are returned. All returns must be prepaid, no collect shipments will be accepted. All returns made for reasons other than defects are subject to a restocking charge. Discontinued goods are not returnable.

Cancellation of orders may be made only with the sellers written consent and shall be subject to cancellation charges.

Governing law

The entering into, construction, interpretation, performance and discharge of the terms set forth herewith shall be governed in accordance with the laws of the State of New York.

Limited One Year Warranty

Seller warrants the material to be free of defects in material and workmanship, under normal use, proper maintenance and proper operation, for a period of one year from date of delivery to a common carrier for shipment to buyer or his designated agent. The obligation of the seller is limited to (1) repair of the material, or (2) replacement of any component or components proven defective in material or workmanship, or (3) refund of the purchase price. Seller shall have no liability for the cost of removal or reinstallation with respect to any replaced or repaired product. The election of said remedies shall be determined by seller in its sole discretion and shall be considered final disposition.

All implied warranties, including the implied warranties of merchantability and fitness for a particular purpose, are hereby disclaimed and excluded. This warranty is in lieu of all other warranties, guarantees, agreements and similar obligations or seller, in no event shall seller be liable for consequential or incidental damages.

Claims

No later than ten (10) days from receipt of material buyer will report, in writing, all claims for any damage, defects or shortages. All claims, including for alleged damaged or defective material, shortage negligence or any other cause whatsoever "(defective performance)", shall deemed waived unless made in writing within the ten (10) day period. However, any defective performance not discoverable within said ten (10) day period (including that discoverable only in processing or in further manufacturing) shall be deemed waived unless made in writing and received by seller in writing within ninety (90) days after receipt or within ten (10) days after buyer learns of the alleged defect, whichever occurs first. Seller's liability shall in no event exceed the purchase price of the material in respect to which the claim is made, or at the election of seller at its sole discretion, and to repair or replacement of such material. Seller shall not be liable for, and buyer assumes all responsibility for, all personal injury and property damage resulting from handling, possession, use or resale of the material by buyer. In no event shall seller be liable for incidental or consequential damages, whether buyer's claim is in contract, negligence, or otherwise. If claim is made, buyer shall permit seller at seller's option to re-inspect the material at buyer's plant or if seller so directs, buyer shall return the material at buyer's expense to seller's facility for re-inspection. No material may be returned to seller without prior written permission from seller.

Force Majeure

Anything in this agreement to the contrary notwithstanding, it is expressly agreed that seller shall not be liable for any damages resulting from, and buyer shall not have the right to cancel this order because of any delays caused in whole or in part by fires, floods, windstorms, tornadoes, wars, riots, insurrections, strikes, lockouts sit-downs, slow-downs, or other labor trouble, causing cessation or interruption of operation or by accident, material shortages, labor or fuel shortages, or inability to procure labor or materials, either on the part of the seller, or because any plant, plants or any portion thereof belonging to seller have been commandeered by the legally constituted public authority, or because of any priorities or preferences established for the manufacture, assembly or allotment of materials by order, decree, or to otherwise of the united states, or by any department, bureau, commission, committee, agent or administrator of any legally constituted public authority in any plant of seller, or any of its suppliers, or resulting from any other cause beyond the control of seller.

Quick Find Index

ITEM NAME PAGE NUMBER

10	
10RS.....	47
10RT.....	47
10RW.....	47
15SSTH.....	39
20	
20CSFLD.....	39
20SSFLD.....	39
20SSTHM.....	40
25CSTHM.....	40
25SSTHM.....	40
26LF.....	32
29LF.....	31
30	
30CSSW.....	42
30CSSWM.....	42
30CSTH.....	42
30CSTHM.....	42
30SSSW.....	41
30SSSWM.....	41
30SSTH.....	41
30SSTHM.....	41
40	
40SSTH.....	43
50	
50SSTH.....	43
58.....	8,9
59.....	8
59DB.....	34
60	
60SSTH.....	43
70	
70SSTH.....	43
100	
100F.....	49
100M.....	46
100MJ.....	58
100MJX.....	58
100S.....	49
100W.....	46
105F.....	49
105S.....	50
105U.....	51
105W.....	51
115F.....	52
115S.....	52
120F.....	52
120S.....	52
120U.....	53
120W.....	53
120WC.....	53
140F.....	55

ITEM NAME PAGE NUMBER

140S.....	55
145.....	16
150F.....	51
200	
200AL.....	15
200F.....	50
200FJW.....	46
200L.....	15
200LF.....	15
200MD.....	48
200MW.....	46
200RTD.....	48
200TVD.....	48
200WD.....	48
200WW.....	46
201.....	20
201A.....	20
201CMLF.....	20
202CMLF.....	20
202LF.....	20
203.....	27
204.....	21
205.....	21
205CM.....	21
205F.....	21, 50
205U.....	51
205WH.....	30
206.....	27
206H.....	27
206HLK.....	27
206VB.....	27
207.....	25
209.....	28
209PX.....	28
212.....	28
212PX.....	28
240H.....	15
240T.....	15
300	
300BV.....	6
400	
434LF.....	33
500	
501.....	13
503.....	12
511.....	13
512.....	13
513.....	13
514.....	12
517.....	12
519.....	14
519TP.....	14
521.....	17
521N.....	17
523.....	19

ITEM NAME PAGE NUMBER

525.....	18
527LF.....	18
529.....	19
530.....	17
532.....	18
600	
646AS.....	22
646BV.....	25
646R.....	25
700	
730.....	14
752CMP.....	7
752N.....	6
752UF.....	7
754D.....	7
754N.....	6
754PXDELFL.....	7
754PXLFL.....	7
755.....	5
755MF.....	7
757.....	4
758.....	5
759.....	4
759MF.....	4
759PLF.....	5
759SDS.....	34
760.....	5
770.....	10
770G.....	10
770N.....	10
771.....	11
772.....	11
772ST.....	11
773.....	11
A	
ADJ.....	30
AHV.....	30
AVA.....	30
AVS.....	30
AZ203.....	22
AZ205.....	22
AZ206.....	23
AZ207.....	24
AZ646.....	22
B	
B1.....	61
B5.....	62-63
B6.....	64-65
B7.....	65
BARV.....	29
BARVY.....	29
BCV.....	29
BFPLF.....	22
BSGV.....	29

ITEM NAME PAGE NUMBER

C	
CIBF.....	56
CICF.....	56
CIF.....	34
CIRF.....	56
CK.....	30
CVC.....	54
D	
DCVLF.....	22
E	
EFV.....	33
EMKL.....	58
F	
FR.....	33
FV.....	33
FY.....	26
G	
GFF.....	57
GFFNA.....	57
GNA.....	57
GNAX.....	57
GSFF.....	57
GSNA.....	57
GSNAFF.....	57
GSNAX.....	57
K	
KEY.....	30
N	
NT.....	29
O	
OP.....	59
OTV.....	34
P	
PBVC.....	34
PVCF.....	56
S	
SBG.....	57
SC.....	54
SGV.....	29
W	
WH.....	59



MATCO-NORCA

Global sourcing. National compliance. Local service.

www.matco-norca.com

CALIFORNIA

Toll Free: 866-532-8306
Fax: 866-532-8307

TEXAS

Toll Free: 800-935-5456
Fax: 713-680-2999

NEW YORK

Toll Free: 800-431-2082
Fax: 845-278-9056