

# 63M Mop Service Basin – 24" x 24" x 10"





Engineered and built to provide years of service, the 63M includes all the features most wanted by maintenance and housekeeping staffs. In addition, a complete range of accessories are also available to let you outfit the Model 63M Mop Basin to best meet your specific applications.



### Features:

- Mop service basins are one-piece molded from high impact resistant DURASTONE® structural fiberglass
- Integral, molded-in drain for connection to 3" ABS, PVC (Sch. 80) or cast iron
- Available drain seals for connection to 2" pipe or 3" soil pipe
- Complete range of accessories to meet specific application needs
- Colorfast marbled white finish
- Easy to install

### Code Listed:

- IAPMO® Listed 
- Warnock Hersey Listed   
CSA Test Standards: Mop Basin – #B45.0 
- American National Standards Institute (ANSI) — Specification Z 124.6 
- American Society of Testing and Materials (ASTM) — D 635, E-84 and E-162 
- CAN/ULC S102-07 Burn and Smoke Test

### Specifications

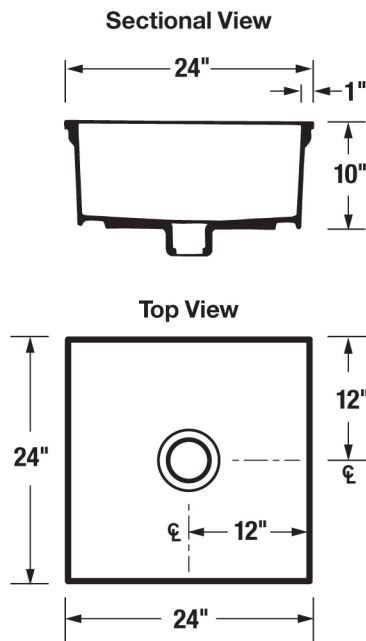

Model	Color	I.P.S.	Size
63M	White	3	24" wide x 24" deep

**Sub-Floor Rough-in — for slab leave 2 1/4" min. depth**

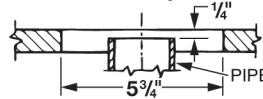

**Anchoring Brackets Provided — for securing mop basin to wall**

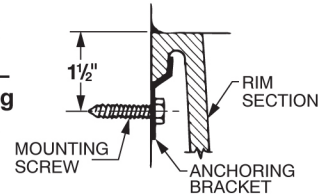

**General:** Furnish and install as shown on plans, Mop Service Basin model 63M, as manufactured by E.L. Mustee & Sons, Inc. Unit to be one-piece, molded fiberglass made with matched metal molds using extreme heat and pressure. Height shall be 10" with not less than 1" wide shoulder. Size 24" x 24" with integrally molded, self-draining shelf. Drain shall be integrally molded, complete with drain seal for installation of 3" ABS, PVC (Sch. #80) and iron pipe. Removable stainless steel strainer. Performance tested to meet or exceed ANSI Specifications Z 124.6. Weight 45 lbs. Install in compliance with local codes.

**Accessories – for complete details and specifications visit [www.mustee.com](http://www.mustee.com)**

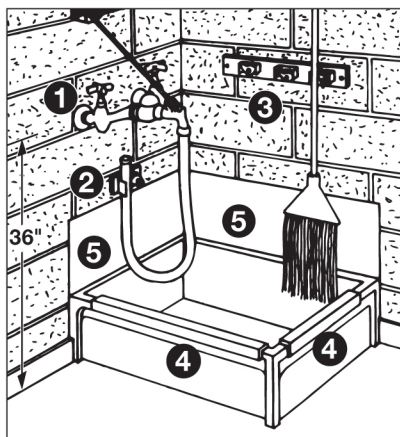

- |                               |  |
|-------------------------------|--|
| <b>Part No.</b>               | <b>Description</b>   |
| 1                             | 63.600A SERVICE SINK FAUCET – heavy-duty chrome plated brass, 8" centers                   |
| 2                             | 65.700 HOSE and HOSE HOLDER – 31" rubber hose and hose holder                              |
| 3                             | 65.600 MOP HANGER – three spring-loaded handle holders                                     |
| 4                             | BUMPER GUARDS – protect rims, snap-on  |
| <b>Impact-Resistant Vinyl</b> |  |
| 63.401                        | – 20 3/4" long, white  |
| <b>Stainless Steel</b>        |  |
| 63.403                        | – 20 3/4" long   |
| 5                             | DURAGUARD™ WALL GUARDS – protect wall surfaces, 12" height, 20 gauge, #304 stainless steel |
| 67.2424                       | – two panels and bracket for 24" x 24" corner  |
| 67.24C                        | – one 24" panel and corner bracket   |
| 65.308                        | DRAIN SEAL – for 2" PVC, ABS and iron pipe   |
| 65.309                        | DRAIN SEAL – for 3" PVC, ABS and iron pipe (included with mop basin)                       |
| 65.311                        | DRAIN SEAL – for 3" soil pipe (No-Hub)   |

To reorder, specify ADV-489